

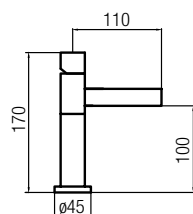



ZC120100

Miscelatore lavabo
Basin mixer
Mitigeur lavabo



Finitura/finish/finition	€
CC-ON	230,00
NS-OP-OL-BO-NO-SE-TE	310,00
NP-TO-FE-TU-CM-CL-NM AN-RU-CO-RO-PO-CE-CN	345,00
OO-OR	460,00

ZC120101

Miscelatore lavabo
Basin mixer
Mitigeur lavabo

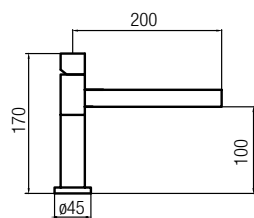

Finitura/finish/finition	€
CC-ON	250,00
NS-OP-OL-BO-NO-SE-TE	340,00
NP-TO-FE-TU-CM-CL-NM AN-RU-CO-RO-PO-CE-CN	375,00
OO-OR	500,00

ZC120102

Miscelatore lavabo
Basin mixer
Mitigeur lavabo

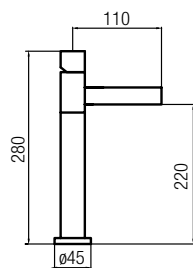

Finitura/finish/finition	€
CC-ON	250,00
NS-OP-OL-BO-NO-SE-TE	340,00
NP-TO-FE-TU-CM-CL-NM AN-RU-CO-RO-PO-CE-CN	375,00
OO-OR	500,00

ZC120103

Miscelatore lavabo
Basin mixer
Mitigeur lavabo

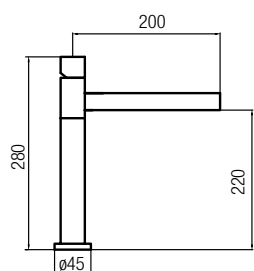

Finitura/finish/finition	€
CC-ON	260,00
NS-OP-OL-BO-NO-SE-TE	350,00
NP-TO-FE-TU-CM-CL-NM AN-RU-CO-RO-PO-CE-CN	390,00
OO-OR	520,00

ZC120104.E

Miscelatore lavabo componente esterno
Basin mixer external component
Mitigeur lavabo composant externes

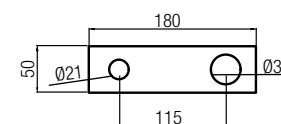

Finitura/finish/finition	€
CC-ON	290,00
NS-OP-OL-BO-NO-SE-TE	390,00
NP-TO-FE-TU-CM-CL-NM AN-RU-CO-RO-PO-CE-CN	435,00
OO-OR	580,00

ZC0D2501GR.C

Componente incasso
Built-in part
Composant intégré



GR 115,00

ZC120105.E

Miscelatore lavabo componente esterno
Basin mixer external component
Mitigeur lavabo composant externes

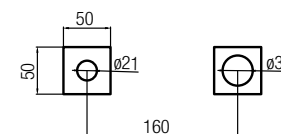

Finitura/finish/finition	€
CC-ON	290,00
NS-OP-OL-BO-NO-SE-TE	390,00
NP-TO-FE-TU-CM-CL-NM AN-RU-CO-RO-PO-CE-CN	435,00
OO-OR	580,00

ZC0D2502GR.C

Componente incasso
Built-in part
Composant intégré



GR 120,00

ZC120106.E

Miscelatore lavabo componente esterno
Basin mixer external component
Mitigeur lavabo composant externes

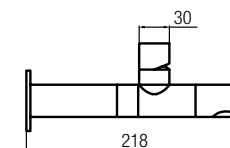

Finitura/finish/finition	€
CC-ON	380,00
NS-OP-OL-BO-NO-SE-TE	515,00
NP-TO-FE-TU-CM-CL-NM AN-RU-CO-RO-PO-CE-CN	570,00
OO-OR	760,00

ZC0FAB01GR

Componente incasso
Built-in part
Composant intégré



GR 240,00

ZC120107.E

Rubinetto lavabo componente esterno
Basin tap external component
Mélangeur lavabo composant externes

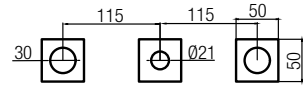

Finitura/finish/finition	€
CC-ON	420,00
NS-OP-OL-BO-NO-SE-TE	565,00
NP-TO-FE-TU-CM-CL-NM AN-RU-CO-RO-PO-CE-CN	630,00
OO-OR	840,00

ZC0TRC01GR.C

Componente incasso
Built-in part
Composant intégré

GR 180,00



ZC120108

Rubinetto lavabo
Basin tap
Mélangeur lavabo

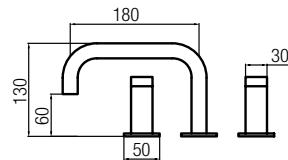

Finitura/finish/finition	€
CC-ON	420,00
NS-OP-OL-BO-NO-SE-TE	565,00
NP-TO-FE-TU-CM-CL-NM AN-RU-CO-RO-PO-CE-CN	630,00
OO-OR	840,00

ZC120111

Miscelatore lavabo
Basin mixer
Mitigeur lavabo

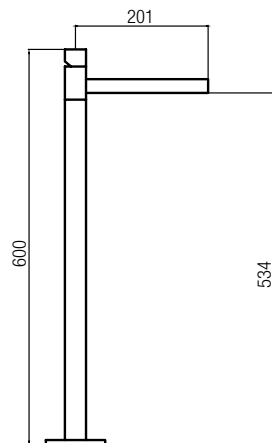

Finitura/finish/finition	€
CC-ON	610,00
NS-OP-OL-BO-NO-SE-TE	825,00
NP-TO-FE-TU-CM-CL-NM AN-RU-CO-RO-PO-CE-CN	915,00
OO-OR	1.220,00

ZC120109.E

Miscelatore lavabo componente esterno
Basin mixer external component
Mitigeur lavabo composant externes

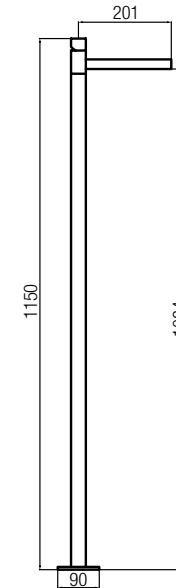

Finitura/finish/finition	€
CC-ON	1.200,00
NS-OP-OL-BO-NO-SE-TE	1.620,00
NP-TO-FE-TU-CM-CL-NM AN-RU-CO-RO-PO-CE-CN	1.800,00
OO-OR	2.400,00

ZC0FAB01GR

Componente incasso
Built-in part
Composant intégré

GR 240,00



ZC120110.E

Miscelatore lavabo componente esterno
Basin mixer external component
Mitigeur lavabo composant externes

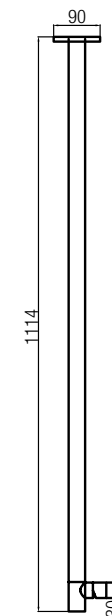

Finitura/finish/finition	€
CC-ON	1.200,00
NS-OP-OL-BO-NO-SE-TE	1.620,00
NP-TO-FE-TU-CM-CL-NM AN-RU-CO-RO-PO-CE-CN	1.800,00
OO-OR	2.400,00

ZC0FAB01GR

Componente incasso
Built-in part
Composant intégré

GR 240,00



ZC120200

Miscelatore bidet
Bidet mixer
Mitigeur bidet

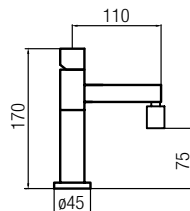

Finitura/finish/finition	€
CC-ON	250,00
NS-OP-OL-BO-NO-SE-TE	340,00
NP-TO-FE-TU-CM-CL-NM AN-RU-CO-RO-PO-CE-CN	375,00
OO-OR	500,00

ZC120300.E

Miscelatore doccia componente esterno
Shower mixer external component
Mitigeur douche composant externes

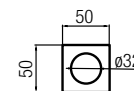

Finitura/finish/finition	€
CC-ON	150,00
NS-OP-OL-BO-NO-SE-TE	205,00
NP-TO-FE-TU-CM-CL-NM AN-RU-CO-RO-PO-CE-CN	225,00
OO-OR	300,00

ZC0D2503GR.C

Componente incasso
Built-in part
Composant intégré

GR

€ 90,00



ZC120201

Rubinetto bidet
Bidet tap
Mélangeur bidet

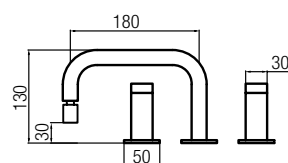

Finitura/finish/finition	€
CC-ON	450,00
NS-OP-OL-BO-NO-SE-TE	585,00
NP-TO-FE-TU-CM-CL-NM AN-RU-CO-RO-PO-CE-CN	650,00
OO-OR	860,00

ZC120301.E

Deviatore a parete componente esterno
Wall diverter external component
Déviateur mural composant externes



oppure
or
ou

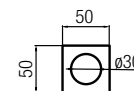

Finitura/finish/finition	€
CC-ON	150,00
NS-OP-OL-BO-NO-SE-TE	205,00
NP-TO-FE-TU-CM-CL-NM AN-RU-CO-RO-PO-CE-CN	225,00
OO-OR	300,00

ZC0DEV01GR

Componente incasso
Built-in part
Composant intégré

GR

€ 120,00



ZC120202.E

Miscelatore bidet componente esterno
Bidet mixer external component
Mitigeur bidet composant externes

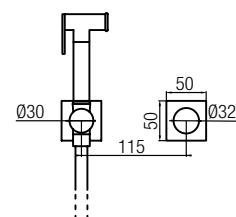

Finitura/finish/finition	€
CC-ON	400,00
NS-OP-OL-BO-NO-SE-TE	540,00
NP-TO-FE-TU-CM-CL-NM AN-RU-CO-RO-PO-CE-CN	600,00
OO-OR	800,00

ZC0D2501GR.C

Componente incasso
Built-in part
Composant intégré

GR

€ 115,00



ZC120302.E

Termostatico doccia componente esterno
Shower thermostatic external component
Thermostatique douche composant externes

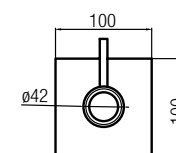

Finitura/finish/finition	€
CC-ON	450,00
NS-OP-OL-BO-NO-SE-TE	605,00
NP-TO-FE-TU-CM-CL-NM AN-RU-CO-RO-PO-CE-CN	675,00
OO-OR	900,00

ZC0FAB02GR.C

Componente incasso
Built-in part
Composant intégré

GR

€ 180,00



ZC120303.E

Miscelatore doccia componente esterno
Shower mixer external component
Mitigeur douche composant externes

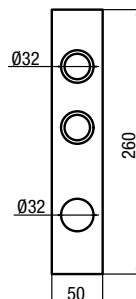

Finitura/finish/finition	€
CC-ON	600,00
NS-OP-OL-BO-NO-SE-TE	810,00
NP-TO-FE-TU-CM-CL-NM AN-RU-CO-RO-PO-CE-CN	900,00
OO-OR	1.200,00

ZC0D2508GR.C

Componente incasso
Built-in part
Composant intégré

€
GR 270,00



ZC120306.E

Miscelatore doccia componente esterno
Shower mixer external component
Mitigeur douche composant externes

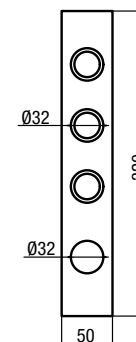

Finitura/finish/finition	€
CC-ON	800,00
NS-OP-OL-BO-NO-SE-TE	1.080,00
NP-TO-FE-TU-CM-CL-NM AN-RU-CO-RO-PO-CE-CN	1.200,00
OO-OR	1.600,00

ZC0D2509GR.C

Componente incasso
Built-in part
Composant intégré

€
GR 360,00



ZC120304.E

Deviatore a parete componente esterno
Wall diverter external component
Déviateur mural composant externes

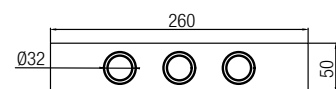

Finitura/finish/finition	€
CC-ON	600,00
NS-OP-OL-BO-NO-SE-TE	810,00
NP-TO-FE-TU-CM-CL-NM AN-RU-CO-RO-PO-CE-CN	900,00
OO-OR	1.200,00

ZC0DEV02GR

Componente incasso
Built-in part
Composant intégré

€
GR 270,00



ZC120307.E

Deviatore a parete componente esterno
Wall diverter external component
Déviateur mural composant externes

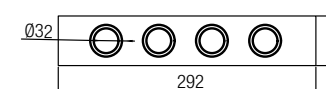

Finitura/finish/finition	€
CC-ON	800,00
NS-OP-OL-BO-NO-SE-TE	1.080,00
NP-TO-FE-TU-CM-CL-NM AN-RU-CO-RO-PO-CE-CN	1.200,00
OO-OR	1.600,00

ZC0DEV03GR

Componente incasso
Built-in part
Composant intégré

€
GR 360,00



ZC120305.E

Miscelatore doccia componente esterno
Shower mixer external component
Mitigeur douche composant externes

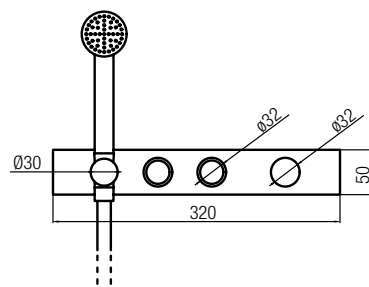

Finitura/finish/finition	€
CC-ON	900,00
NS-OP-OL-BO-NO-SE-TE	1.215,00
NP-TO-FE-TU-CM-CL-NM AN-RU-CO-RO-PO-CE-CN	1.350,00
OO-OR	1.800,00

ZC0D2513GR.C

Componente incasso
Built-in part
Composant intégré

€
GR 360,00



ZC120308.E

Miscelatore doccia componente esterno
Shower mixer external component
Mitigeur douche composant externes

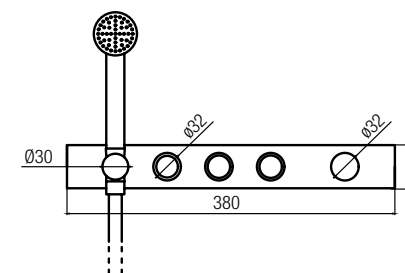

Finitura/finish/finition	€
CC-ON	1.100,00
NS-OP-OL-BO-NO-SE-TE	1.485,00
NP-TO-FE-TU-CM-CL-NM AN-RU-CO-RO-PO-CE-CN	1.650,00
OO-OR	2.200,00

ZC0D2510GR.C

Componente incasso
Built-in part
Composant intégré

€
GR 450,00



ZC120309.E

Miscelatore doccia componente esterno
Shower mixer external component
Mitigeur douche composant externes

4 outlets

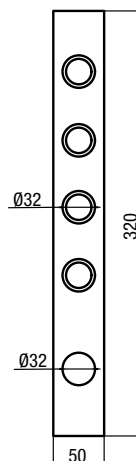

Finitura/finish/finition	€
CC-ON	1.000,00
NS-OP-OL-BO-NO-SE-TE	1.350,00
NP-TO-FE-TU-CM-CL-NM AN-RU-CO-RO-PO-CE-CN	1.500,00
OO-OR	2.000,00

ZC0D2511GR.C

Componente incasso
Built-in part
Composant intégré



GR	€
GR	450,00

ZC120310.E

Deviatore a parete componente esterno
Wall diverter external component
Déviateur mural composant externes

5 outlets

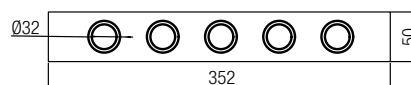

Finitura/finish/finition	€
CC-ON	1.000,00
NS-OP-OL-BO-NO-SE-TE	1.350,00
NP-TO-FE-TU-CM-CL-NM AN-RU-CO-RO-PO-CE-CN	1.500,00
OO-OR	2.000,00

ZC0DEV04GR

Componente incasso
Built-in part
Composant intégré



GR	€
GR	450,00

ZC120311.E

Miscelatore doccia componente esterno
Shower mixer external component
Mitigeur douche composant externes

3 outlets

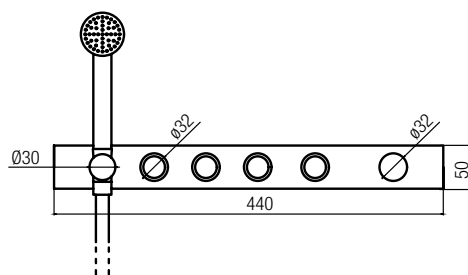

Finitura/finish/finition	€
CC-ON	1.300,00
NS-OP-OL-BO-NO-SE-TE	1.755,00
NP-TO-FE-TU-CM-CL-NM AN-RU-CO-RO-PO-CE-CN	1.950,00
OO-OR	2.600,00

ZC0D2512GR.C

Componente incasso
Built-in part
Composant intégré



GR	€
GR	540,00

ZC120312.E

Colonna doccia
componente esterno
Shower column
external component
Colonne de douche
composant externes

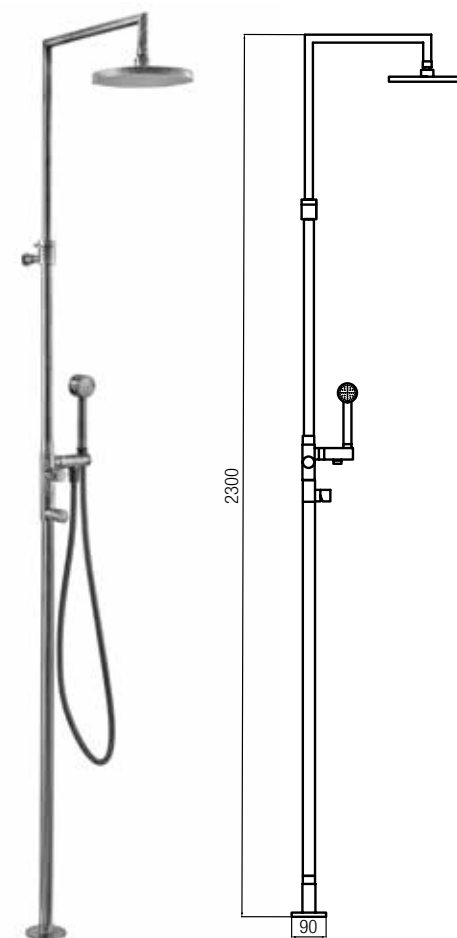

Finitura/finish/finition	€
CC-ON	2.600,00
NS-OP-OL-BO-NO-SE-TE	3.510,00
NP-TO-FE-TU-CM-CL-NM AN-RU-CO-RO-PO-CE-CN	3.900,00
OO-OR	5.200,00

ZC0FAB01GR

Componente incasso
Built-in part
Composant intégré



GR	€
GR	240,00

ZC120313.E

Colonna doccia
componente esterno
Shower column
external component
Colonne de douche
composant externes

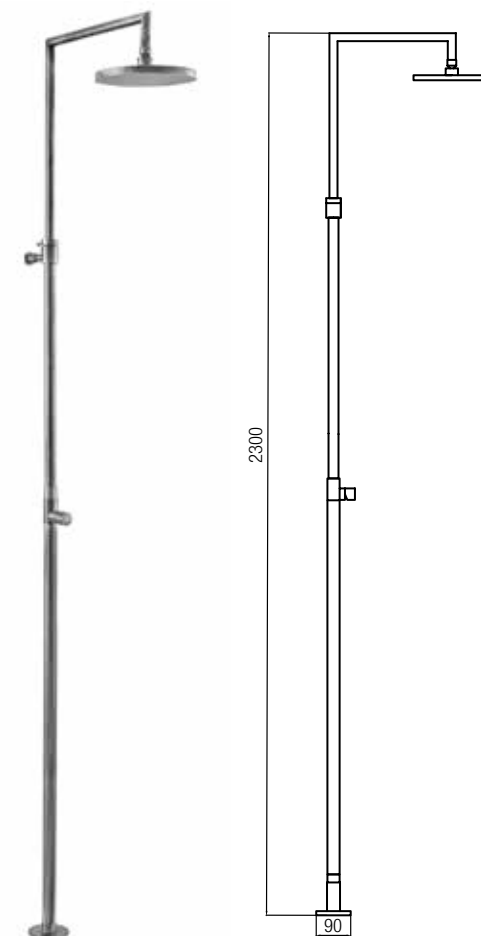

Finitura/finish/finition	€
CC-ON	2.000,00
NS-OP-OL-BO-NO-SE-TE	2.700,00
NP-TO-FE-TU-CM-CL-NM AN-RU-CO-RO-PO-CE-CN	3.000,00
OO-OR	4.000,00

ZC0FAB01GR

Componente incasso
Built-in part
Composant intégré



GR	€
GR	240,00

ZC120400.E

Miscelatore vasca componente esterno
Bath mixer external component
Mitigeur bain composant externes

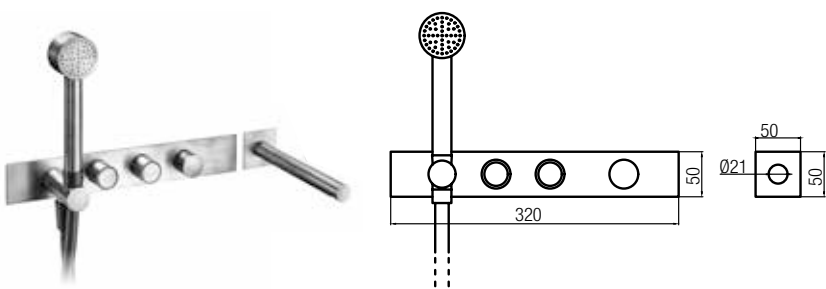

Finitura/finish/finition	€
CC-ON	1.100,00
NS-OP-OL-BO-NO-SE-TE	1.485,00
NP-TO-FE-TU-CM-CL-NM AN-RU-CO-RO-PO-CE-CN	1.650,00
OO-OR	2.200,00

ZC0D2513GR.C

Componente incasso
Built-in part
Composant intégré



GR	€
GR	360,00

ZC000728

Bocca da soffitto
Ceiling spout
Bec au plafond

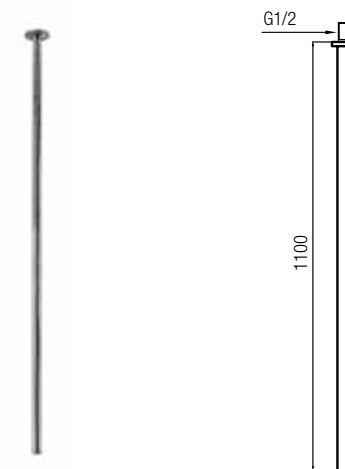

Finitura/finish/finition	€
CC-ON	630,00
NS-OP-OL-BO-NO-SE-TE	850,00
NP-TO-FE-TU-CM-CL-NM AN-RU-CO-RO-PO-CE-CN	945,00
OO-OR	1.260,00

ZC120401

Rubinetto vasca
Bath tap
Mélangeur bain

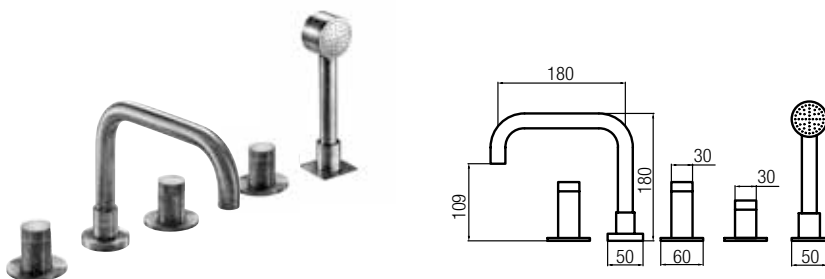

Finitura/finish/finition	€
CC-ON	1.100,00
NS-OP-OL-BO-NO-SE-TE	1.485,00
NP-TO-FE-TU-CM-CL-NM AN-RU-CO-RO-PO-CE-CN	1.650,00
OO-OR	2.200,00

ZC000717

Piastra wc
Wc plate
Plaque de wc

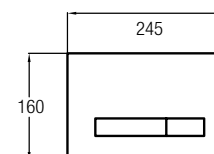

Finitura/finish/finition	€
CC-ON	500,00
NS-OP-OL-BO-NO-SE-TE	675,00
NP-TO-FE-TU-CM-CL-NM AN-RU-CO-RO-PO-CE-CN	750,00
OO-OR	1.000,00

ZC000830

Bocca a cascata
Waterfall spout
Bec cascade

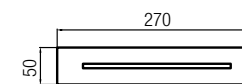

Finitura/finish/finition	€
CC-ON	600,00
NS-OP-OL-BO-NO-SE-TE	810,00
NP-TO-FE-TU-CM-CL-NM AN-RU-CO-RO-PO-CE-CN	900,00
OO-OR	1.200,00

ZC120402.E

Miscelatore vasca
componente esterno
Bath mixer external
component
Mitigeur bain
composant externes

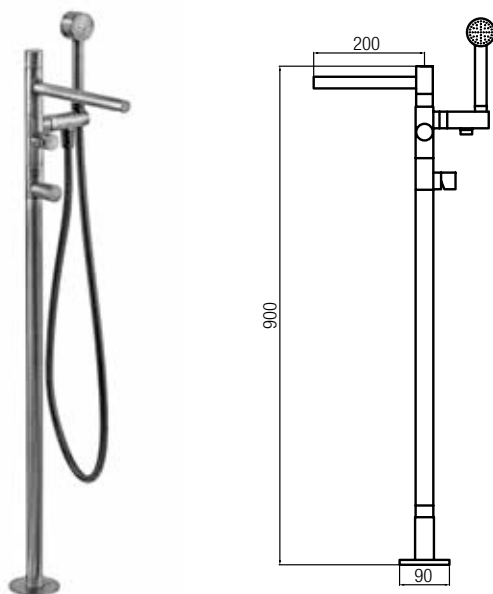

Finitura/finish/finition	€
CC-ON	1.900,00
NS-OP-OL-BO-NO-SE-TE	2.565,00
NP-TO-FE-TU-CM-CL-NM AN-RU-CO-RO-PO-CE-CN	2.850,00
OO-OR	3.800,00

ZC0FAB01GR

Componente incasso
Built-in part
Composant intégré



GR	€
GR	240,00

ZC000812

Braccio doccia
Shower arm
Bras de douche

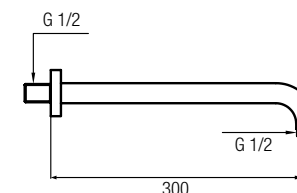

Finitura/finish/finition	€
CC-ON	120,00
NS-OP-OL-BO-NO-SE-TE	162,00
NP-TO-FE-TU-CM-CL-NM AN-RU-CO-RO-PO-CE-CN	180,00
OO-OR	240,00

ZC000811

Braccio doccia da soffitto
Ceiling shower arm
Bras de douche au plafond

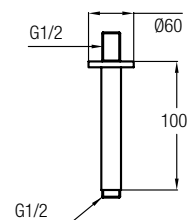

Finitura/finish/finition	€
CC-ON	120,00
NS-OP-OL-BO-NO-SE-TE	162,00
NP-TO-FE-TU-CM-CL-NM AN-RU-CO-RO-PO-CE-CN	180,00
OO-OR	240,00

ZC000726

Duplex con presa acqua
Duplex with water outlet
Duplex avec pris d'eau

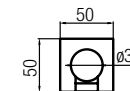

Finitura/finish/finition	€
CC-ON	90,00
NS-OP-OL-BO-NO-SE-TE	120,00
NP-TO-FE-TU-CM-CL-NM AN-RU-CO-RO-PO-CE-CN	135,00
OO-OR	180,00

ZC000832

Soffione ø 200 mm
Shower head ø 200 mm
Pommeau de douche ø 200 mm

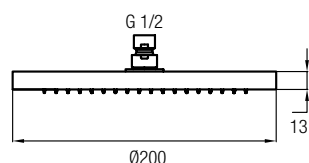

Finitura/finish/finition	€
CC-ON	380,00
NS-OP-OL-BO-NO-SE-TE	513,00
NP-TO-FE-TU-CM-CL-NM AN-RU-CO-RO-PO-CE-CN	570,00
OO-OR	760,00

ZC000701

Scarico con troppo pieno
Pop up waste with overflow
Vidage avec trop plein

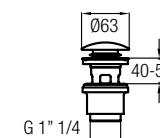

Finitura/finish/finition	€
CC-ON	65,00
NS-OP-OL-BO-NO-SE-TE	90,00
NP-TO-FE-TU-CM-CL-NM AN-RU-CO-RO-PO-CE-CN	100,00
OO-OR	130,00

ZC000833

Doccetta
Hand shower
Douchette

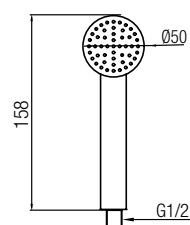

Finitura/finish/finition	€
CC-ON	180,00
NS-OP-OL-BO-NO-SE-TE	243,00
NP-TO-FE-TU-CM-CL-NM AN-RU-CO-RO-PO-CE-CN	270,00
OO-OR	360,00

ZC000702

Scarico senza troppo pieno
Pop up waste without overflow
Vidage sans trop plein

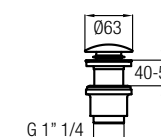

Finitura/finish/finition	€
CC-ON	65,00
NS-OP-OL-BO-NO-SE-TE	90,00
NP-TO-FE-TU-CM-CL-NM AN-RU-CO-RO-PO-CE-CN	100,00
OO-OR	130,00

ZC000834

Flessibile
Flexible hose
Flexible de douche



Finitura/finish/finition	€
CC-ON	60,00
NS-OP-OL-BO-NO-SE-TE	81,00
NP-TO-FE-TU-CM-CL-NM AN-RU-CO-RO-PO-CE-CN	90,00
OO-OR	120,00

ZC000705

Sifone
Syphon
Siphon

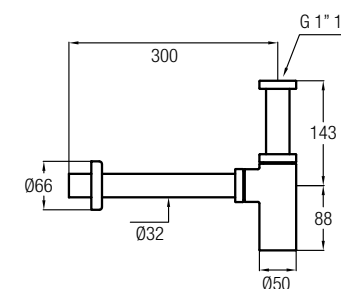

Finitura/finish/finition	€
CC-ON	110,00
NS-OP-OL-BO-NO-SE-TE	150,00
NP-TO-FE-TU-CM-CL-NM AN-RU-CO-RO-PO-CE-CN	165,00
OO-OR	220,00

ZC000727

Scarico senza troppo pieno
Pop up waste without overflow
Vidage sans trop plein

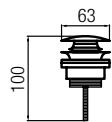

Finitura/finish/finition	€
CC-ON	90,00
NS-OP-OL-BO-NO-SE-TE	120,00
NP-TO-FE-TU-CM-CL-NM AN-RU-CO-RO-PO-CE-CN	140,00
OO-OR	180,00

ZC650100

Portasalviette l. 300 mm
Towel holder mm 300 l.
Porte-serviette mm 300

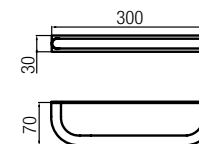

Finitura/finish/finition	€
CC-ON	210,00
NS-OP-OL-BO-NO-SE-TE	285,00
NP-TO-FE-TU-CM-CL-NM AN-RU-CO-RO-PO-CE-CN	315,00
OO-OR	420,00

ZC000729

Scarico senza troppo pieno
Pop up waste without overflow
Vidage sans trop plein

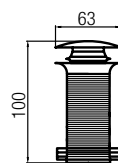

Finitura/finish/finition	€
CC-ON	90,00
NS-OP-OL-BO-NO-SE-TE	120,00
NP-TO-FE-TU-CM-CL-NM AN-RU-CO-RO-PO-CE-CN	140,00
OO-OR	180,00

ZC650101

Portasalviette l. 450 mm
Towel holder mm 450 l.
Porte-serviette mm 450

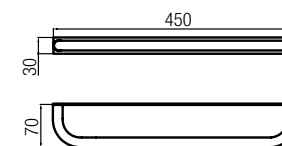

Finitura/finish/finition	€
CC-ON	250,00
NS-OP-OL-BO-NO-SE-TE	340,00
NP-TO-FE-TU-CM-CL-NM AN-RU-CO-RO-PO-CE-CN	375,00
OO-OR	500,00

ZC650102

Portasalviette l. 600 mm
Towel holder mm 600 l.
Porte-serviette mm 600

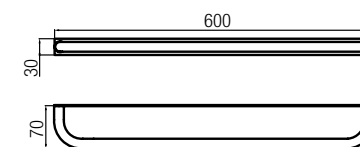

Finitura/finish/finition	€
CC-ON	290,00
NS-OP-OL-BO-NO-SE-TE	390,00
NP-TO-FE-TU-CM-CL-NM AN-RU-CO-RO-PO-CE-CN	435,00
OO-OR	580,00

ZC650103

Mensola portasalviette
Towel rack
Étagère porte-serviette

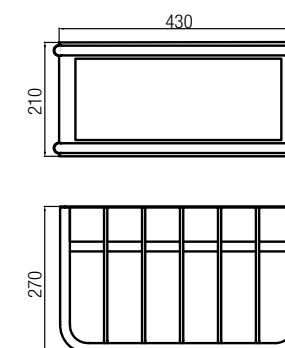

Finitura/finish/finition	€
CC-ON	750,00
NS-OP-OL-BO-NO-SE-TE	1.015,00
NP-TO-FE-TU-CM-CL-NM AN-RU-CO-RO-PO-CE-CN	1.125,00
OO-OR	1.500,00

ZC650104

Portarotolo
Toilet paper holder
Porte papier hygiénique

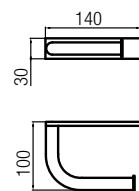

ZC650105

Appendino
Hook
Crochet

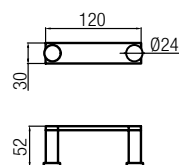

ZC650106

Portascopino
Toilet brush
Porte-brosse WC

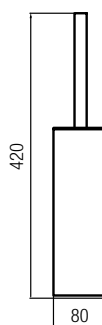

Finitura/finish/finition	€
CC-ON	180,00
NS-OP-OL-BO-NO-SE-TE	245,00
NP-TO-FE-TU-CM-CL-NM AN-RU-CO-RO-PO-CE-CN	270,00
OO-OR	360,00

Finitura/finish/finition	€
CC-ON	210,00
NS-OP-OL-BO-NO-SE-TE	285,00
NP-TO-FE-TU-CM-CL-NM AN-RU-CO-RO-PO-CE-CN	315,00
OO-OR	420,00

Finitura/finish/finition	€
CC-ON	220,00
NS-OP-OL-BO-NO-SE-TE	295,00
NP-TO-FE-TU-CM-CL-NM AN-RU-CO-RO-PO-CE-CN	330,00
OO-OR	440,00

EXPO ZC

Espositore ZC Zanetti Chini Rubinetterie comprensivo di 9 rubinetti montati su basetta (COLORE E MODELLO A SCELTA)
Display ZC Zanetti Chini Rubinetterie including 9 taps mounted on base (FINISH AND MODEL TO CHOOSE)
Display ZC Zanetti Chini Rubinetterie comprenant 9 robinets montés sur la base (COULEUR ET MODÈLE AU CHOIX)

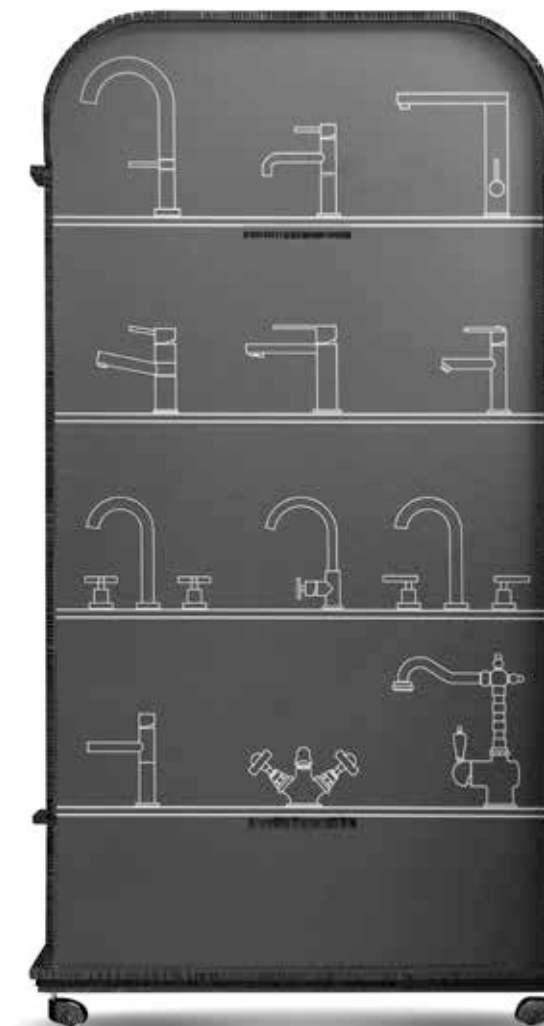
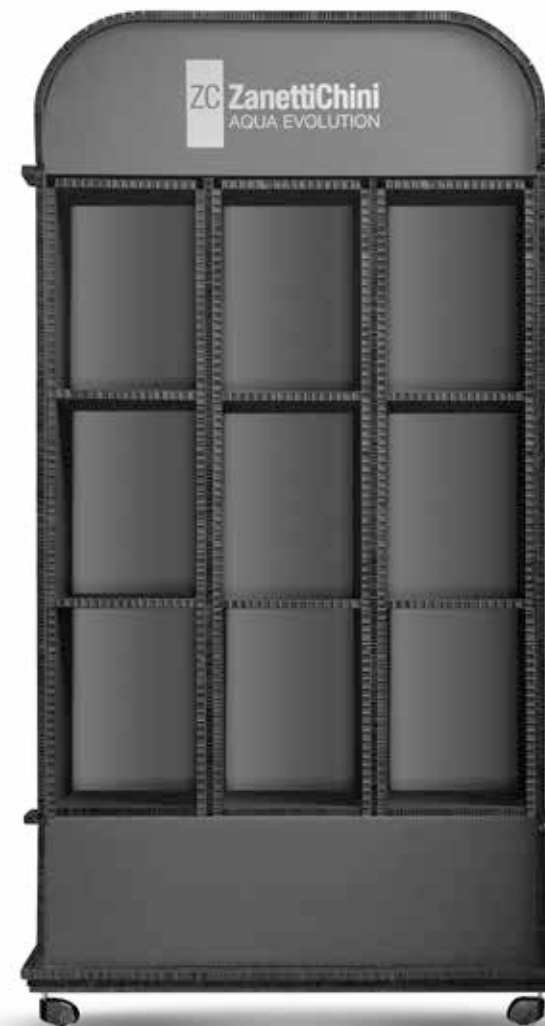

102x38xh193 cm

Finitura/finish/finition €

3.200,00

Legenda finiture | finishes key | légende des finitions

CROMO	CC
OTTONE NATURALE	ON
NICHEL SPAZZOLATO	NS
OTTONE PROTETTO OPACO	OP
OTTONE PROTETTO LUCIDO	OL
BIANCO OPACO	BO
NERO OPACO	NO
SENAPE	SE
TERRACOTTA	TE
NICHEL SPAZZOLATO PROTETTO OPACO	NP
BRONZO PROTETTO OPACO	TO
RAME PROTETTO OPACO	RO
FERRO	FE
TUSCAN	TU
CARAMELLO	CM
COLORI RAL	CL
NERO MARTELLATO	NM
ANTRACITE	AN
RUGGINE	RU
CORTEN	CO
POMPEI	PO
CEMENTO	CE
CANNELLA	CN
ORO	OO
ORO ROSA	OR

Zanetti Chini si riserva il diritto di apportare le modifiche che ritiene opportune ad articoli, finiture e misure al fine di migliorare il prodotto. Le illustrazioni contenute nel presente depliant non comportano obbligo di fedele riproduzione.

Zanetti Chini reserves the right to make any changes it deems appropriate to articles, finishes and measures in order to improve the product. The illustrations in this brochure not entail obligation to faithful reproduction.

Photo: Alberto Aliverti_ Whiterobot
Grafica: Barbara Dapas_ Punto a capo