

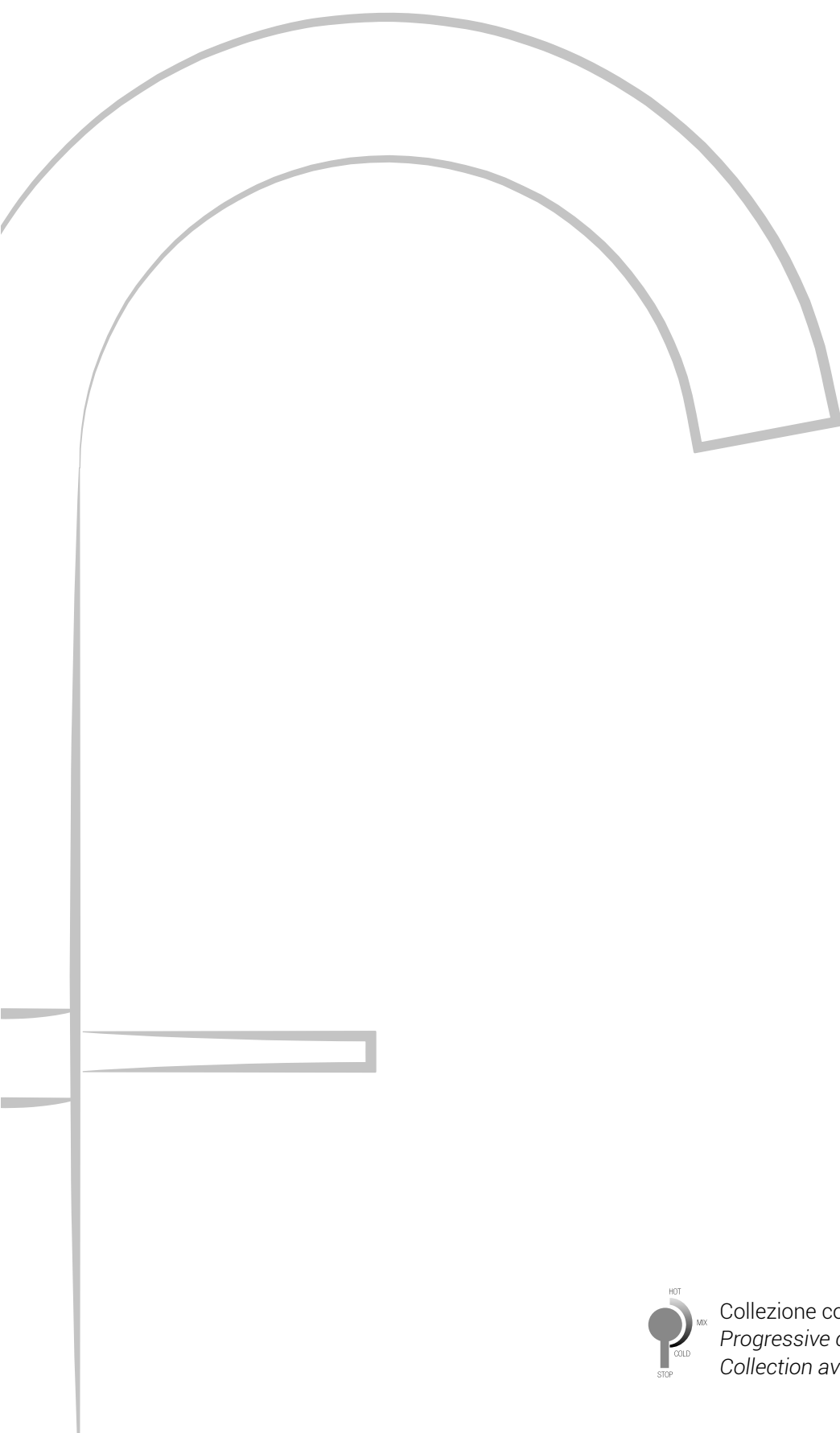

**BATHROOM**collection<  
*price list 2022/2023*

4	ZC2
10	ZC3
16	ZC4
20	ZC5
30	ZC6
36	ZC7
40	ZC8
46	ZC9
52	ZC11
58	ZC21_22_23
62	ZC31
68	ZC32
76	ACCESSORI <i>ACCESSORIES</i> ACCESSOIRES
86	COMPONENTI IDRAULICI <i>HYDRAULIC COMPONENTS</i> COMPOSANTS HYDRAULIQUES
94	ACCESSORI BAGNO <i>BATH ACCESSORIES</i> ACCESSOIRES DE BAIN
103	FINITURE <i>FINISHES</i> FINITIONS





ZC2



Collezione con cartuccia progressiva.  
*Progressive cartridge system*  
*Collection avec des cartouches progressive*

## ZC200100

Miscelatore lavabo  
Basin mixer  
Mitigeur lavabo

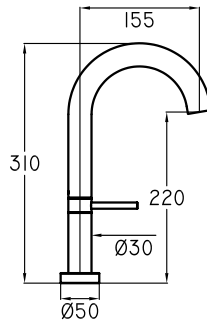

Finitura/finish/finition	€
CC-ON	310,00
NS-OP-OL-BO-NO-SE-TE	420,00
NP-TO-FE-TU-CM-CL-NM AN-RU-CO-RO-PO-CE-CN	465,00
OO-OR	620,00

## ZC200101

Miscelatore lavabo  
Basin mixer  
Mitigeur lavabo

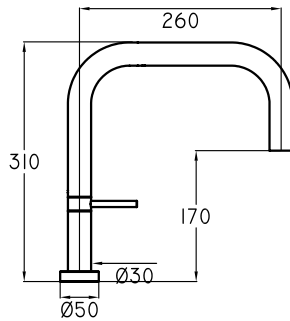

Finitura/finish/finition	€
CC-ON	330,00
NS-OP-OL-BO-NO-SE-TE	445,00
NP-TO-FE-TU-CM-CL-NM AN-RU-CO-RO-PO-CE-CN	495,00
OO-OR	660,00

## ZC200102

Miscelatore lavabo  
Basin mixer  
Mitigeur lavabo

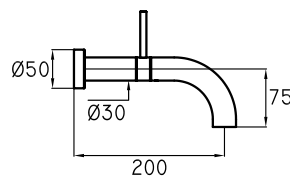

Finitura/finish/finition	€
CC-ON	450,00
NS-OP-OL-BO-NO-SE-TE	610,00
NP-TO-FE-TU-CM-CL-NM AN-RU-CO-RO-PO-CE-CN	675,00
OO-OR	900,00

## ZC200104

Miscelatore lavabo  
Basin mixer  
Mitigeur lavabo

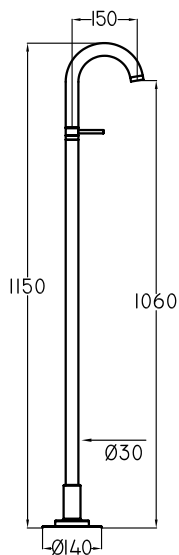
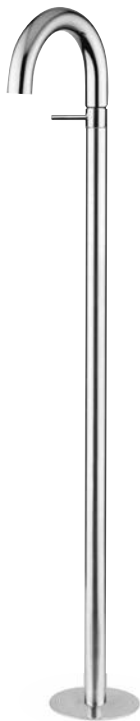

Finitura/finish/finition	€
CC-ON	1.200,00
NS-OP-OL-BO-NO-SE-TE	1.620,00
NP-TO-FE-TU-CM-CL-NM AN-RU-CO-RO-PO-CE-CN	1.800,00
OO-OR	2.400,00

## ZC200105

Miscelatore lavabo  
Basin mixer  
Mitigeur lavabo

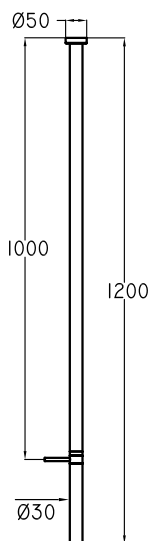

Finitura/finish/finition	€
CC-ON	1.100,00
NS-OP-OL-BO-NO-SE-TE	1.485,00
NP-TO-FE-TU-CM-CL-NM AN-RU-CO-RO-PO-CE-CN	1.650,00
OO-OR	2.200,00

## ZC200200

Miscelatore bidet  
Bidet mixer  
Mitigeur bidet

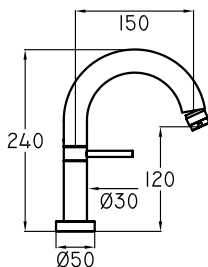

Finitura/finish/finition	€
CC-ON	310,00
NS-OP-OL-BO-NO-SE-TE	420,00
NP-TO-FE-TU-CM-CL-NM AN-RU-CO-RO-PO-CE-CN	465,00
OO-OR	620,00

## ZC200300.E

Miscelatore doccia componente esterno  
Shower mixer external component  
Mitigeur douche composant externe

1 outlet

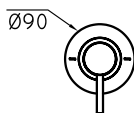

Finitura/finish/finition	€
CC-ON	120,00
NS-OP-OL-BO-NO-SE-TE	165,00
NP-TO-FE-TU-CM-CL-NM AN-RU-CO-RO-PO-CE-CN	180,00
OO-OR	240,00



### ZCOD3503GR

Componente incasso  
Built-in part  
Composant intégré

GR

€

90,00



### ZCOD3503GR.C

Incasso per cartongesso  
Built-in part for drywall  
C. intégré pour cloison sèche

GR

€

120,00

## ZC200301.E

Miscelatore doccia componente esterno  
Shower mixer  
external component  
Mitigeur douche  
composant externe

1 outlet

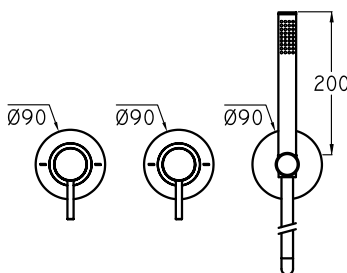

Finitura/finish/finition	€
CC-ON	340,00
NS-OP-OL-BO-NO-SE-TE	460,00
NP-TO-FE-TU-CM-CL-NM AN-RU-CO-RO-PO-CE-CN	510,00
OO-OR	680,00



### ZCOD3508GR

Componente incasso  
Built-in part  
Composant intégré

GR

€

180,00



### ZCOD3508GR.C

Incasso per cartongesso  
Built-in part for drywall  
C. intégré pour cloison sèche

GR

€

240,00

## ZC200400

Miscelatore vasca  
Bath mixer  
Mitigeur bain

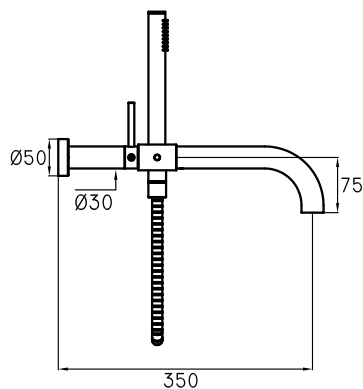

Finitura/finish/finition €

CC-ON 1.250,00

NS-OP-OL-BO-NO-SE-TE 1.690,00

NP-TO-FE-TU-CM-CL-NM  
AN-RU-CO-RO-PO-CE-CN 1.880,00

OO-OR 2.500,00

## ZC200401

Miscelatore vasca  
Bath mixer  
Mitigeur bain

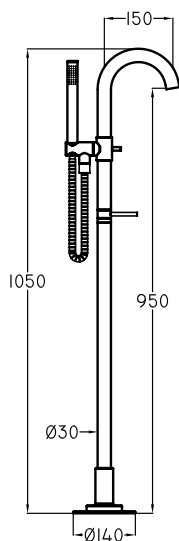

Finitura/finish/finition €

CC-ON 1.400,00

NS-OP-OL-BO-NO-SE-TE 1.890,00

NP-TO-FE-TU-CM-CL-NM  
AN-RU-CO-RO-PO-CE-CN 2.100,00

OO-OR 2.800,00





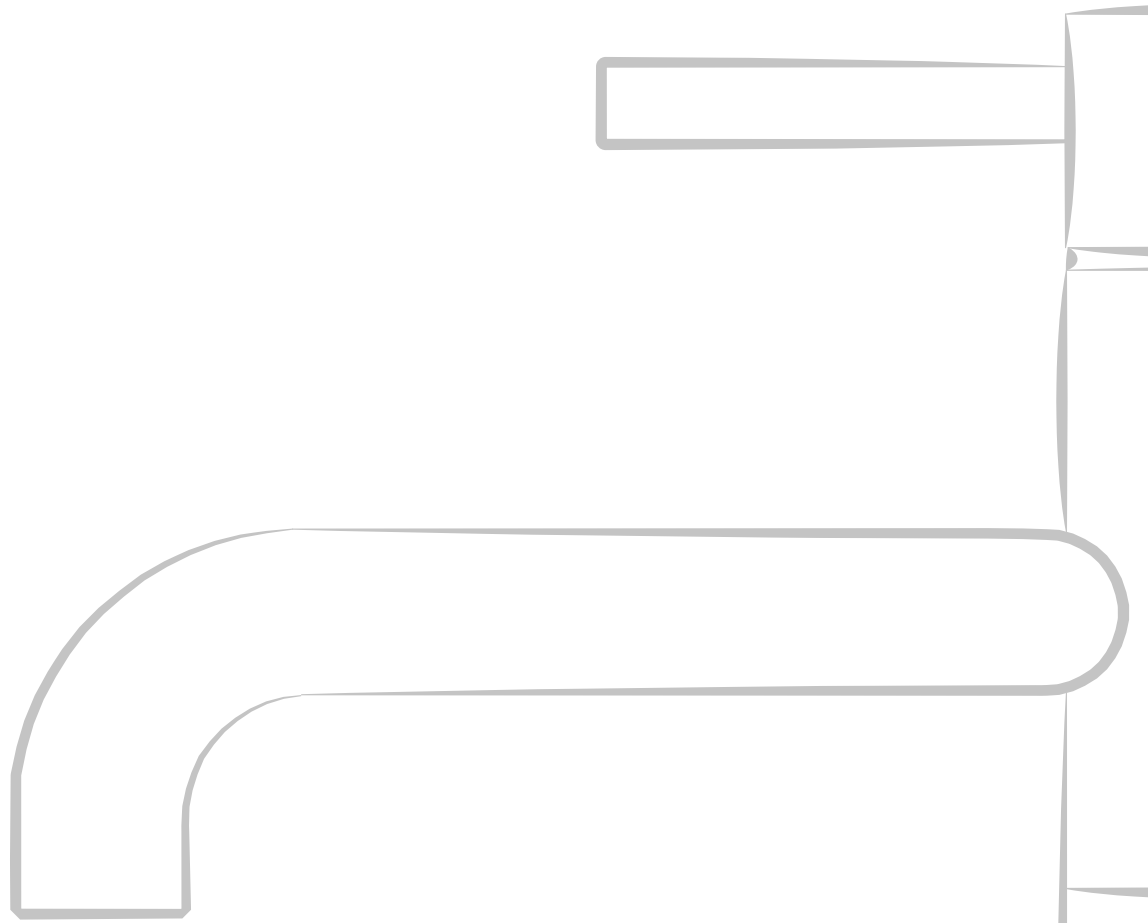

ZC3

## ZC300100

Miscelatore lavabo  
Basin mixer  
Mitigeur lavabo

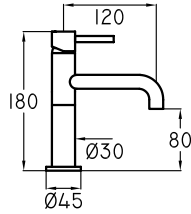

Finitura/finish/finition	€
CC-ON	200,00
NS-OP-OL-BO-NO-SE-TE	270,00
NP-TO-FE-TU-CM-CL-NM AN-RU-CO-RO-PO-CE-CN	300,00
OO-OR	400,00

## ZC300101

Miscelatore lavabo  
Basin mixer  
Mitigeur lavabo

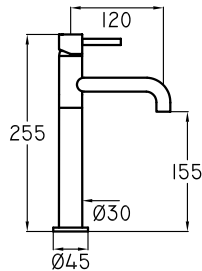

Finitura/finish/finition	€
CC-ON	210,00
NS-OP-OL-BO-NO-SE-TE	285,00
NP-TO-FE-TU-CM-CL-NM AN-RU-CO-RO-PO-CE-CN	315,00
OO-OR	420,00

## ZC300102

Miscelatore lavabo  
Basin mixer  
Mitigeur lavabo

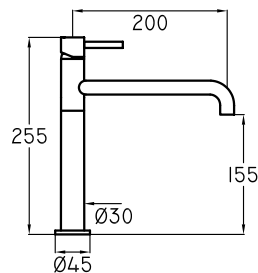

Finitura/finish/finition	€
CC-ON	220,00
NS-OP-OL-BO-NO-SE-TE	300,00
NP-TO-FE-TU-CM-CL-NM AN-RU-CO-RO-PO-CE-CN	330,00
OO-OR	440,00

## ZC300103

Miscelatore lavabo  
Basin mixer  
Mitigeur lavabo

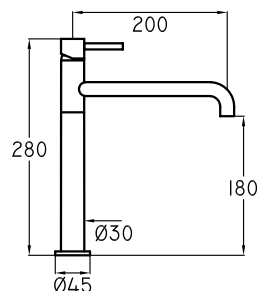

Finitura/finish/finition	€
CC-ON	230,00
NS-OP-OL-BO-NO-SE-TE	310,00
NP-TO-FE-TU-CM-CL-NM AN-RU-CO-RO-PO-CE-CN	345,00
OO-OR	460,00

## ZC300104

Miscelatore lavabo  
Basin mixer  
Mitigeur lavabo

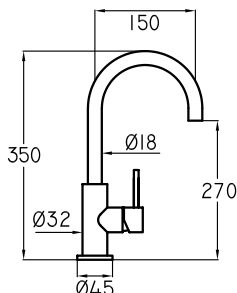

Finitura/finish/finition	€
CC-ON	210,00
NS-OP-OL-BO-NO-SE-TE	285,00
NP-TO-FE-TU-CM-CL-NM AN-RU-CO-RO-PO-CE-CN	315,00
OO-OR	420,00

## ZC300105

Miscelatore lavabo  
Basin mixer  
Mitigeur lavabo

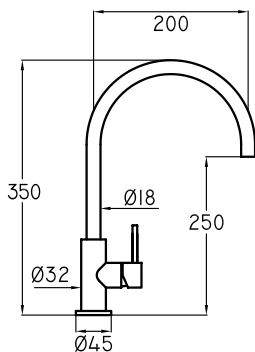

Finitura/finish/finition	€
CC-ON	220,00
NS-OP-OL-BO-NO-SE-TE	300,00
NP-TO-FE-TU-CM-CL-NM AN-RU-CO-RO-PO-CE-CN	330,00
OO-OR	440,00

## ZC300106.E

Miscelatore lavabo componente esterno  
Basin mixer external component  
Mitigeur lavabo composant externe

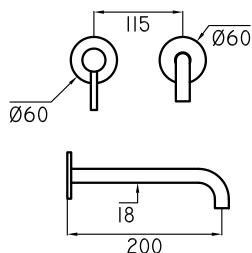

Finitura/finish/finition	€
CC-ON	170,00
NS-OP-OL-BO-NO-SE-TE	230,00
NP-TO-FE-TU-CM-CL-NM AN-RU-CO-RO-PO-CE-CN	255,00
OO-OR	340,00

## ZC0D2501GR

Componente incasso  
Built-in part  
Composant intégré



	€
GR	115,00

## ZC0D2501GR.C

Incasso per cartongesso  
Built-in part for drywall  
C. intégré pour cloison sèche



	€
GR	145,00

## ZC300107.E

Miscelatore lavabo componente esterno  
*Basin mixer external component*  
 Mitigeur lavabo composant externe

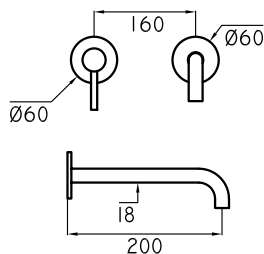

Finitura/finish/finition €

CC-ON 170,00

NS-OP-OL-BO-NO-SE-TE 230,00

NP-TO-FE-TU-CM-CL-NM  
 AN-RU-CO-RO-PO-CE-CN 255,00

OO-OR 340,00

## ZC0D2502GR

Componente incasso  
*Built-in part*  
 Composant intégré

€

GR 120,00

## ZC0D2502GR.C

Incasso per cartongesso  
*Built-in part for drywall*  
 C. intégré pour cloison sèche

€

GR 150,00

## ZC300200

Miscelatore bidet  
*Bidet mixer*  
 Mitigeur bidet

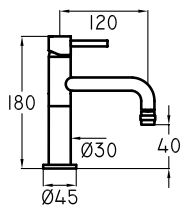

Finitura/finish/finition €

CC-ON 220,00

NS-OP-OL-BO-NO-SE-TE 300,00

NP-TO-FE-TU-CM-CL-NM  
 AN-RU-CO-RO-PO-CE-CN 330,00

OO-OR 440,00

## ZC300201

Miscelatore bidet  
*Bidet mixer*  
 Mitigeur bidet

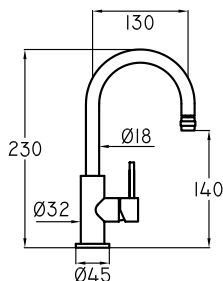

Finitura/finish/finition €

CC-ON 220,00

NS-OP-OL-BO-NO-SE-TE 300,00

NP-TO-FE-TU-CM-CL-NM  
 AN-RU-CO-RO-PO-CE-CN 330,00

OO-OR 440,00

## ZC300300.E

Miscelatore doccia componente esterno  
*Shower mixer external component*  
 Mitigeur douche composant externe

1 outlet



Finitura/finish/finition	€
CC-ON	110,00
NS-OP-OL-BO-NO-SE-TE	150,00
NP-TO-FE-TU-CM-CL-NM AN-RU-CO-RO-PO-CE-CN	165,00
OO-OR	220,00



### ZC0D2503GR

Componente incasso  
*Built-in part*  
 Composant intégré

GR	€
	90,00



### ZC0D2503GR.C

Incasso per cartongesso  
*Built-in part for drywall*  
 C. intégré pour cloison sèche

GR	€
	120,00

## ZC300301.E

Miscelatore doccia componente esterno  
*Shower mixer external component*  
 Mitigeur douche composant externe

2 outlets

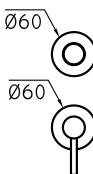

Finitura/finish/finition	€
CC-ON	200,00
NS-OP-OL-BO-NO-SE-TE	270,00
NP-TO-FE-TU-CM-CL-NM AN-RU-CO-RO-PO-CE-CN	300,00
OO-OR	400,00



### ZC0D2504GR

Componente incasso  
*Built-in part*  
 Composant intégré

GR	€
	145,00



### ZC0D2504GR.C

Incasso per cartongesso  
*Built-in part for drywall*  
 C. intégré pour cloison sèche

GR	€
	175,00

## ZC300302.E

Miscelatore doccia  
 componente esterno  
*Shower mixer  
 external component*  
 Mitigeur douche  
 composant externe

1 outlet

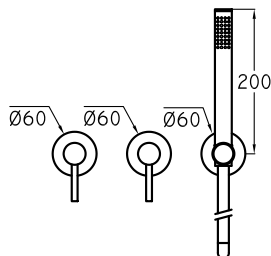

Finitura/finish/finition	€
CC-ON	330,00
NS-OP-OL-BO-NO-SE-TE	445,00
NP-TO-FE-TU-CM-CL-NM AN-RU-CO-RO-PO-CE-CN	495,00
OO-OR	660,00



### ZC0D2506GR

Componente incasso  
*Built-in part*  
 Composant intégré

GR	€
	180,00



### ZC0D2506GR.C

Incasso per cartongesso  
*Built-in part for drywall*  
 C. intégré pour cloison sèche

GR	€
	240,00

## ZC300303.E

Miscelatore doccia componente esterno  
*Shower mixer external component*  
 Mitigeur douche composant externe

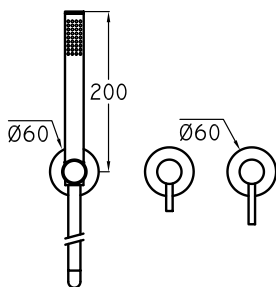

Finitura/finish/finition	€
CC-ON	330,00
NS-OP-OL-BO-NO-SE-TE	445,00
NP-TO-FE-TU-CM-CL-NM AN-RU-CO-RO-PO-CE-CN	495,00
OO-OR	660,00



## ZC0D2505GR

Componente incasso  
*Built-in part*  
 Composant intégré

	€
GR	210,00



## ZC0D2505GR.C

Incasso per cartongesso  
*Built-in part for drywall*  
 C. intégré pour cloison sèche

	€
GR	240,00

## ZC300400.E

Miscelatore vasca  
 componente esterno  
*Bath mixer*  
*external component*  
 Mitigeur bain  
 composant externe

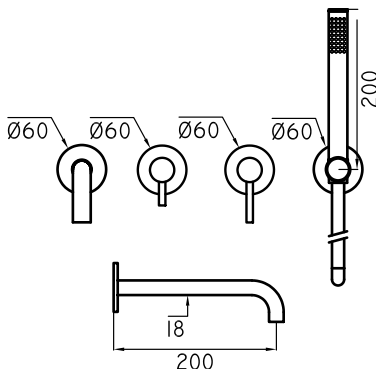

Finitura/finish/finition	€
CC-ON	420,00
NS-OP-OL-BO-NO-SE-TE	570,00
NP-TO-FE-TU-CM-CL-NM AN-RU-CO-RO-PO-CE-CN	630,00
OO-OR	840,00



## ZC0D2505GR

Componente incasso  
*Built-in part*  
 Composant intégré

	€
GR	210,00



## ZC0D2505GR.C

Incasso per cartongesso  
*Built-in part for drywall*  
 C. intégré pour cloison sèche

	€
GR	240,00

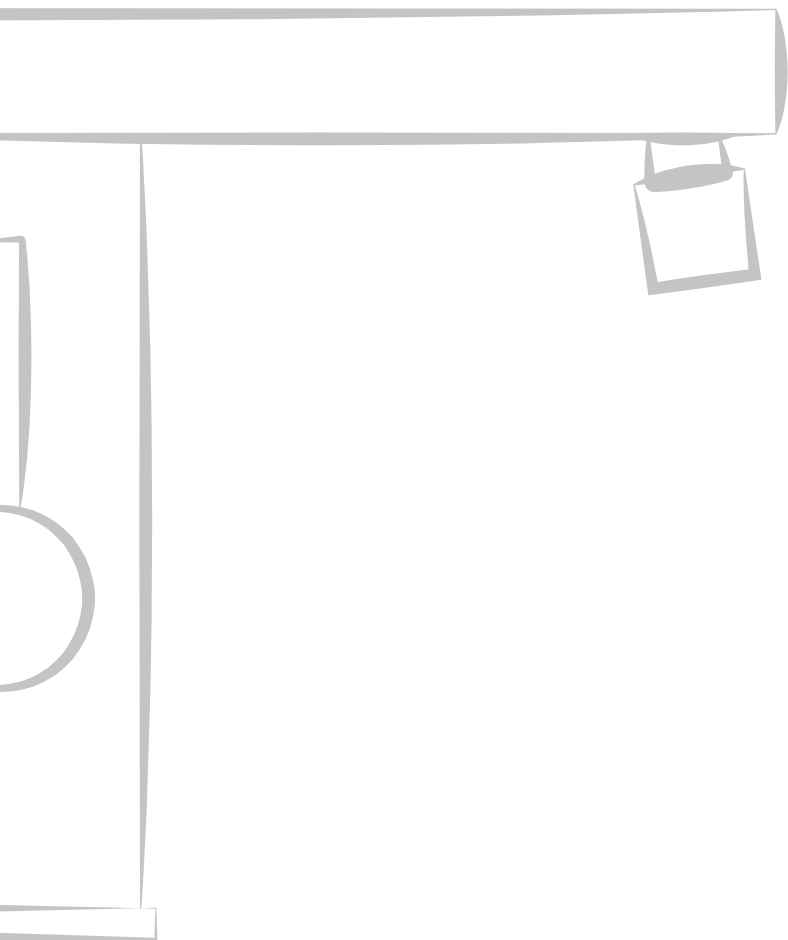

ZC4



## ZC400100

Miscelatore lavabo  
*Basin mixer*  
 Mitigeur lavabo

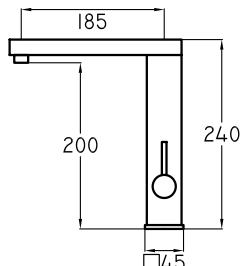

Finitura/finish/finition	€
CC-ON	420,00
NS-OP-OL-BO-NO-SE-TE	570,00
NP-TO-FE-TU-CM-CL-NM AN-RU-CO-RO-PO-CE-CN	630,00
OO-OR	840,00

## ZC400101

Miscelatore lavabo  
*Basin mixer*  
 Mitigeur lavabo

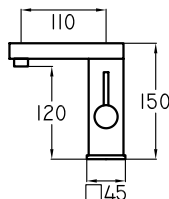

Finitura/finish/finition	€
CC-ON	420,00
NS-OP-OL-BO-NO-SE-TE	570,00
NP-TO-FE-TU-CM-CL-NM AN-RU-CO-RO-PO-CE-CN	630,00
OO-OR	840,00

## ZC400103.E

Miscelatore lavabo componente esterno  
*Basin mixer external component*  
 Mitigeur lavabo composant externe

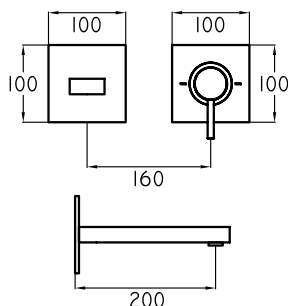

Finitura/finish/finition	€
CC-ON	320,00
NS-OP-OL-BO-NO-SE-TE	435,00
NP-TO-FE-TU-CM-CL-NM AN-RU-CO-RO-PO-CE-CN	480,00
OO-OR	640,00

## ZC0D3502GR

Componente incasso  
*Built-in part*  
 Composant intégré



GR	€
GR	120,00

## ZC0D3502GR.C

Incasso per cartongesso  
*Built-in part for drywall*  
 C. intégré pour cloison sèche



GR	€
GR	150,00

## ZC400200

Miscelatore bidet  
*Bidet mixer*  
 Mitigeur bidet

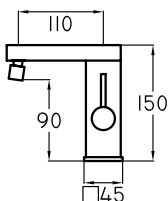

Finitura/finish/finition	€
CC-ON	410,00
NS-OP-OL-BO-NO-SE-TE	555,00
NP-TO-FE-TU-CM-CL-NM AN-RU-CO-RO-PO-CE-CN	615,00
OO-OR	820,00

## ZC400300.E

Miscelatore doccia componente esterno  
*Shower mixer external component*  
 Mitigeur douche composant externe

1 outlet

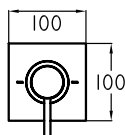

Finitura/finish/finition	€
CC-ON	140,00
NS-OP-OL-BO-NO-SE-TE	190,00
NP-TO-FE-TU-CM-CL-NM AN-RU-CO-RO-PO-CE-CN	210,00
OO-OR	280,00



### ZC0D3503GR

Componente incasso  
*Built-in part*  
 Composant intégré

	€
GR	90,00



### ZC0D3503GR.C

Incasso per cartongesso  
*Built-in part for drywall*  
 C. intégré pour cloison sèche

	€
GR	120,00

## ZC400301.E

Miscelatore doccia  
 componente esterno  
*Shower mixer  
 external component*  
 Mitigeur douche  
 composant externe

3 outlets

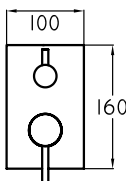

Finitura/finish/finition	€
CC-ON	260,00
NS-OP-OL-BO-NO-SE-TE	350,00
NP-TO-FE-TU-CM-CL-NM AN-RU-CO-RO-PO-CE-CN	390,00
OO-OR	520,00



### ZC0D3505GR

Componente incasso  
*Built-in part*  
 Composant intégré

	€
GR	145,00



### ZC0D3505GR.C

Incasso per cartongesso  
*Built-in part for drywall*  
 C. intégré pour cloison sèche

	€
GR	175,00

## ZC400302.E

Miscelatore doccia componente esterno  
*Shower mixer external component*  
 Mitigeur douche composant externe

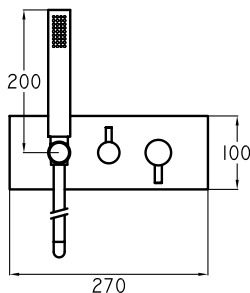

Finitura/finish/finition	€
CC-ON	520,00
NS-OP-OL-BO-NO-SE-TE	700,00
NP-TO-FE-TU-CM-CL-NM AN-RU-CO-RO-PO-CE-CN	780,00
OO-OR	1.040,00

## ZC0D3509GR

Componente incasso  
*Built-in part*  
 Composant intégré

GR	€
	200,00

## ZC0D3509GR

Incasso per cartongesso  
*Built-in part for drywall*  
 C. intégré pour cloison sèche

GR	€
	230,00

## ZC400303.E

Miscelatore doccia componente esterno  
*Shower mixer external component*  
 Mitigeur douche composant externe

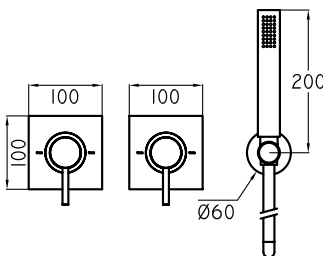
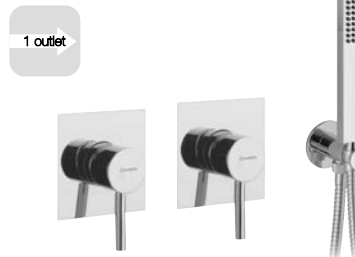

Finitura/finish/finition	€
CC-ON	380,00
NS-OP-OL-BO-NO-SE-TE	515,00
NP-TO-FE-TU-CM-CL-NM AN-RU-CO-RO-PO-CE-CN	570,00
OO-OR	760,00

## ZC0D3508GR

Componente incasso  
*Built-in part*  
 Composant intégré

GR	€
	180,00

## ZC0D3508GR.C

Incasso per cartongesso  
*Built-in part for drywall*  
 C. intégré pour cloison sèche

GR	€
	210,00

## ZC400400.E

Miscelatore vasca componente esterno  
*Bath mixer external component*  
 Mitigeur bain composant externe

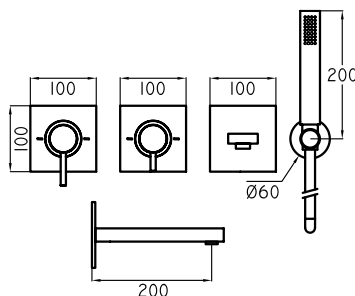
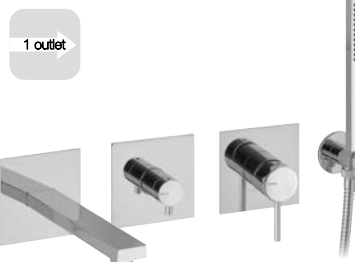

Finitura/finish/finition	€
CC-ON	560,00
NS-OP-OL-BO-NO-SE-TE	760,00
NP-TO-FE-TU-CM-CL-NM AN-RU-CO-RO-PO-CE-CN	840,00
OO-OR	1.120,00

## ZC0D3506GR

Componente incasso  
*Built-in part*  
 Composant intégré

GR	€
	210,00

## ZC0D3506GR.C

Incasso per cartongesso  
*Built-in part for drywall*  
 C. intégré pour cloison sèche

GR	€
	240,00



ZC5

## ZC500100

Miscelatore lavabo  
Basin mixer  
Mitigeur lavabo

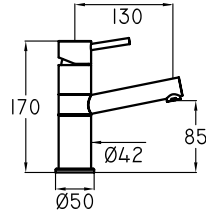

Finitura/finish/finition	€
CC-ON	180,00
NS-OP-OL-BO-NO-SE-TE	245,00
NP-TO-FE-TU-CM-CL-NM AN-RU-CO-RO-PO-CE-CN	270,00
OO-OR	360,00

## ZC500101

Miscelatore lavabo  
Basin mixer  
Mitigeur lavabo

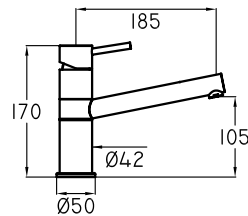

Finitura/finish/finition	€
CC-ON	195,00
NS-OP-OL-BO-NO-SE-TE	265,00
NP-TO-FE-TU-CM-CL-NM AN-RU-CO-RO-PO-CE-CN	295,00
OO-OR	390,00

## ZC500102

Miscelatore lavabo  
Basin mixer  
Mitigeur lavabo

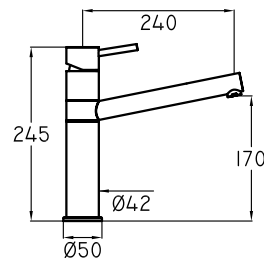

Finitura/finish/finition	€
CC-ON	210,00
NS-OP-OL-BO-NO-SE-TE	285,00
NP-TO-FE-TU-CM-CL-NM AN-RU-CO-RO-PO-CE-CN	315,00
OO-OR	420,00

## ZC500103

Miscelatore lavabo  
Basin mixer  
Mitigeur lavabo

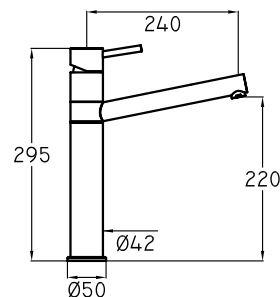

Finitura/finish/finition	€
CC-ON	225,00
NS-OP-OL-BO-NO-SE-TE	305,00
NP-TO-FE-TU-CM-CL-NM AN-RU-CO-RO-PO-CE-CN	340,00
OO-OR	450,00

## ZC500104.E

Miscelatore lavabo componente esterno  
*Basin mixer external component*  
 Mitigeur lavabo composant externe

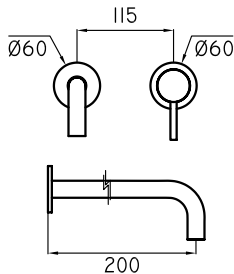

Finitura/finish/finition	€
CC-ON	150,00
NS-OP-OL-BO-NO-SE-TE	205,00
NP-TO-FE-TU-CM-CL-NM AN-RU-CO-RO-PO-CE-CN	225,00
OO-OR	300,00

## ZC0D3501GR

Componente incasso  
*Built-in part*  
 Composant intégré



GR	€
GR	115,00

## ZC0D3501GR.C

Incasso per cartongesso  
*Built-in part for drywall*  
 C. intégré pour cloison sèche



GR	€
GR	145,00

## ZC500105.E

Miscelatore lavabo componente esterno  
*Basin mixer external component*  
 Mitigeur lavabo composant externe

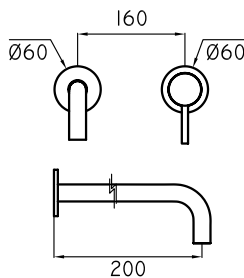

Finitura/finish/finition	€
CC-ON	150,00
NS-OP-OL-BO-NO-SE-TE	205,00
NP-TO-FE-TU-CM-CL-NM AN-RU-CO-RO-PO-CE-CN	225,00
OO-OR	300,00

## ZC0D3502GR

Componente incasso  
*Built-in part*  
 Composant intégré



GR	€
GR	120,00

## ZC0D3502GR.C

Incasso per cartongesso  
*Built-in part for drywall*  
 C. intégré pour cloison sèche



GR	€
GR	150,00

## ZC500106

Miscelatore lavabo  
*Basin mixer*  
 Mitigeur lavabo

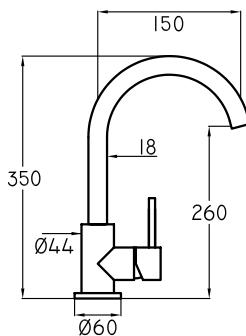

Finitura/finish/finition	€
CC-ON	210,00
NS-OP-OL-BO-NO-SE-TE	285,00
NP-TO-FE-TU-CM-CL-NM AN-RU-CO-RO-PO-CE-CN	315,00
OO-OR	420,00

## ZC500107

Miscelatore lavabo  
Basin mixer  
Mitigeur lavabo

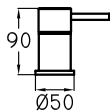

Finitura/finish/finition	€
CC-ON	160,00
NS-OP-OL-BO-NO-SE-TE	220,00
NP-TO-FE-TU-CM-CL-NM AN-RU-CO-RO-PO-CE-CN	240,00
OO-OR	320,00

## ZC500108

Miscelatore lavabo  
Basin mixer  
Mitigeur lavabo

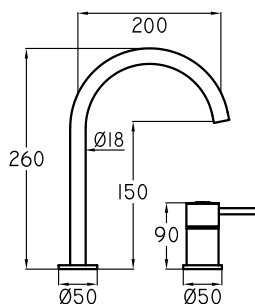

Finitura/finish/finition	€
CC-ON	230,00
NS-OP-OL-BO-NO-SE-TE	310,00
NP-TO-FE-TU-CM-CL-NM AN-RU-CO-RO-PO-CE-CN	345,00
OO-OR	460,00

## ZC500110.E

Miscelatore lavabo componente esterno  
Basin mixer external component  
Mitigeur lavabo composant externe

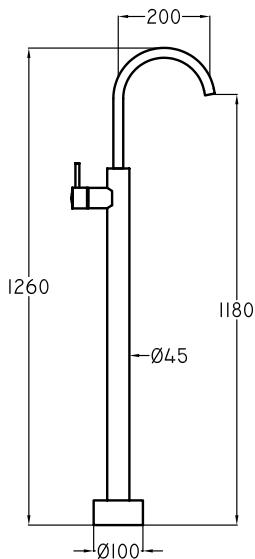

Finitura/finish/finition	€
CC-ON	900,00
NS-OP-OL-BO-NO-SE-TE	1.215,00
NP-TO-FE-TU-CM-CL-NM AN-RU-CO-RO-PO-CE-CN	1.350,00
OO-OR	1.800,00

## ZC0D3507GR

Componente incasso  
Built-in part  
Composant intégré



GR 210,00

## ZC500200

Miscelatore bidet  
*Bidet mixer*  
Mitigeur bidet

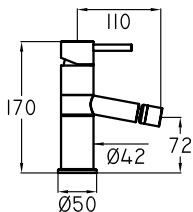

Finitura/finish/finition	€
CC-ON	180,00
NS-OP-OL-BO-NO-SE-TE	245,00
NP-TO-FE-TU-CM-CL-NM AN-RU-CO-RO-PO-CE-CN	270,00
OO-OR	360,00

## ZC500201.E

Miscelatore bidet componente esterno  
*Bidet mixer external component*  
Mitigeur bidet composant externe

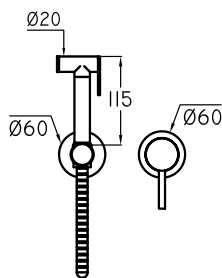

Finitura/finish/finition	€
CC-ON	225,00
NS-OP-OL-BO-NO-SE-TE	305,00
NP-TO-FE-TU-CM-CL-NM AN-RU-CO-RO-PO-CE-CN	340,00
OO-OR	450,00

### ZCOD3501GR

Componente incasso  
*Built-in part*  
Composant intégré



GR	€
GR	115,00

### ZCOD3501GR.C

Incasso per cartongesso  
*Built-in part for drywall*  
C. intégré pour cloison sèche



GR	€
GR	145,00

## ZC500300.E

Miscelatore doccia componente esterno  
*Shower mixer external component*  
Mitigeur douche composant externe

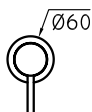

Finitura/finish/finition	€
CC-ON	100,00
NS-OP-OL-BO-NO-SE-TE	135,00
NP-TO-FE-TU-CM-CL-NM AN-RU-CO-RO-PO-CE-CN	150,00
OO-OR	200,00

### ZCOD3503GR

Componente incasso  
*Built-in part*  
Composant intégré



GR	€
GR	90,00

### ZCOD3503GR.C

Incasso per cartongesso  
*Built-in part for drywall*  
C. intégré pour cloison sèche



GR	€
GR	120,00



## ZC500301.E

Miscelatore doccia componente esterno  
*Shower mixer external component*  
 Mitigeur douche composant externe

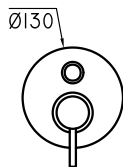

Finitura/finish/finition	€
CC-ON	160,00
NS-OP-OL-BO-NO-SE-TE	215,00
NP-TO-FE-TU-CM-CL-NM AN-RU-CO-RO-PO-CE-CN	240,00
OO-OR	320,00



### ZCOD3504GR

Componente incasso  
*Built-in part*  
 Composant intégré

GR	€
	135,00



### ZCOD3504GR.C

Incasso per cartongesso  
*Built-in part for drywall*  
 C. intégré pour cloison sèche

GR	€
	165,00

## ZC500302.E

Miscelatore doccia componente esterno  
*Shower mixer external component*  
 Mitigeur douche composant externe

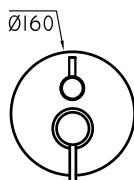

Finitura/finish/finition	€
CC-ON	210,00
NS-OP-OL-BO-NO-SE-TE	285,00
NP-TO-FE-TU-CM-CL-NM AN-RU-CO-RO-PO-CE-CN	315,00
OO-OR	420,00



### ZCOD3505GR

Componente incasso  
*Built-in part*  
 Composant intégré

GR	€
	145,00



### ZCOD3505GR.C

Incasso per cartongesso  
*Built-in part for drywall*  
 C. intégré pour cloison sèche

GR	€
	175,00

## ZC500303.E

Miscelatore doccia componente esterno  
*Shower mixer external component*  
 Mitigeur douche composant externe

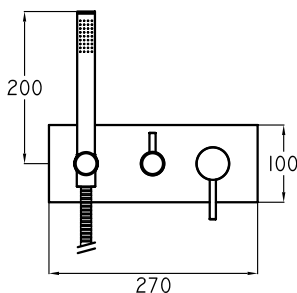

Finitura/finish/finition	€
CC-ON	400,00
NS-OP-OL-BO-NO-SE-TE	540,00
NP-TO-FE-TU-CM-CL-NM AN-RU-CO-RO-PO-CE-CN	600,00
OO-OR	800,00



### ZCOD3509GR

Componente incasso  
*Built-in part*  
 Composant intégré

GR	€
	200,00



### ZCOD3509GR.C

Incasso per cartongesso  
*Built-in part for drywall*  
 C. intégré pour cloison sèche

GR	€
	230,00

## ZC500304.E

Miscelatore doccia componente esterno  
*Shower mixer external component*  
 Mitigeur douche composant externe

1 outlet

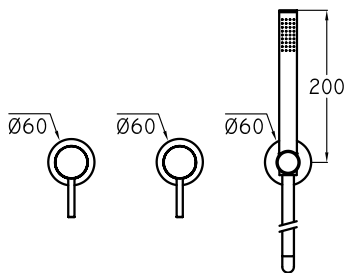

Finitura/finish/finition €

CC-ON 300,00

NS-OP-OL-BO-NO-SE-TE 405,00

NP-TO-FE-TU-CM-CL-NM  
 AN-RU-CO-RO-PO-CE-CN 450,00

OO-OR 600,00



## ZC0D3508GR

Componente incasso  
*Built-in part*  
 Composant intégré

GR € 180,00



## ZC0D3508GR.C

Incasso per cartongesso  
*Built-in part for drywall*  
 C. intégré pour cloison sèche

GR € 240,00

## ZC500305

Miscelatore doccia  
*Shower mixer*  
 Mitigeur douche

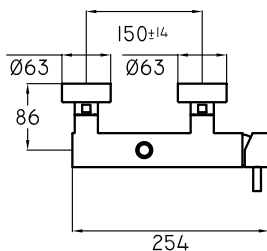

Finitura/finish/finition €

CC-ON 400,00

NS-OP-OL-BO-NO-SE-TE 540,00

NP-TO-FE-TU-CM-CL-NM  
 AN-RU-CO-RO-PO-CE-CN 600,00

OO-OR 800,00

## ZC500307.E

Deviatore componente esterno  
*Diverter external component*  
 Dèviateur composant externe

3 outlets

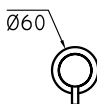

Finitura/finish/finition €

CC-ON 100,00

NS-OP-OL-BO-NO-SE-TE 135,00

NP-TO-FE-TU-CM-CL-NM  
 AN-RU-CO-RO-PO-CE-CN 150,00

OO-OR 200,00



## ZC0DEV01GR

Componente incasso  
*Built-in part*  
 Composant intégré

GR € 120,00

## ZC500306.E

Colonna doccia componente esterno  
 Shower column external component  
 Colonne de douche composant externe

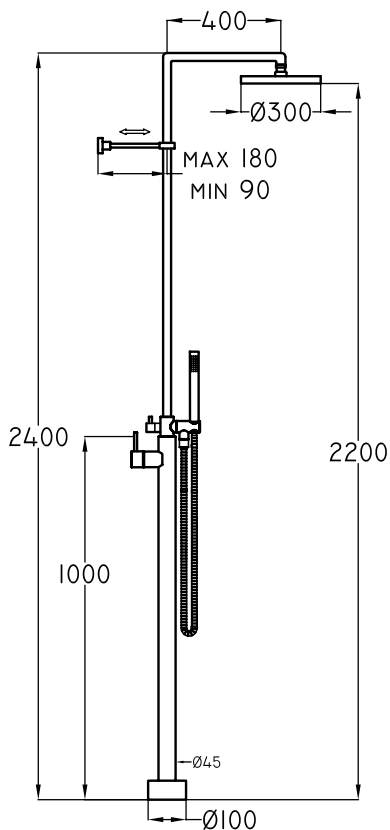

Finitura/finish/finition	€
CC-ON	1.500,00
NS-OP-OL-BO-NO-SE-TE	2.025,00
NP-TO-FE-TU-CM-CL-NM AN-RU-CO-RO-PO-CE-CN	2.250,00
OO-OR	3.000,00

## ZC0D3507GR

Componente incasso  
 Built-in part  
 Composant intégré



€
GR 210,00

## ZC500308.E

Miscelatore doccia componente esterno  
 Shower mixer external component  
 Mitigeur douche composant externe

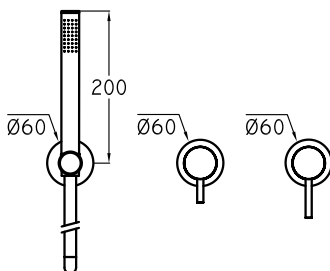

Finitura/finish/finition	€
CC-ON	350,00
NS-OP-OL-BO-NO-SE-TE	475,00
NP-TO-FE-TU-CM-CL-NM AN-RU-CO-RO-PO-CE-CN	525,00
OO-OR	700,00

## ZC0D3506GR

Componente incasso  
 Built-in part  
 Composant intégré

€
GR 210,00



## ZC0D3506GR.C

Incasso per cartongesso  
 Built-in part for drywall  
 C. intégré pour cloison sèche

€
GR 240,00



## ZC500400.E

Miscelatore vasca componente esterno  
*Bath mixer external component*  
 Mitigeur bain composant externe

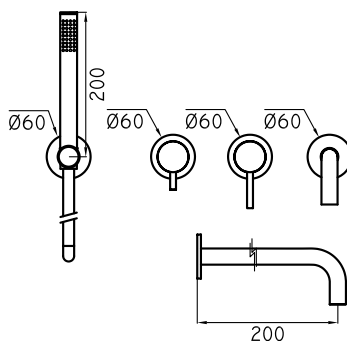

Finitura/finish/finition €

CC-ON 450,00

NS-OP-OL-BO-NO-SE-TE 610,00

NP-TO-FE-TU-CM-CL-NM  
 AN-RU-CO-RO-PO-CE-CN 675,00

OO-OR 900,00

## ZCOD3506GR

Componente incasso  
*Built-in part*  
 Composant intégré



€

GR 210,00

## ZCOD3506GR.C

Incasso per cartongesso  
*Built-in part for drywall*  
 C. intégré pour cloison sèche



€

GR 240,00

## ZC500402

Miscelatore vasca  
*Bath mixer*  
 Mitigeur bain

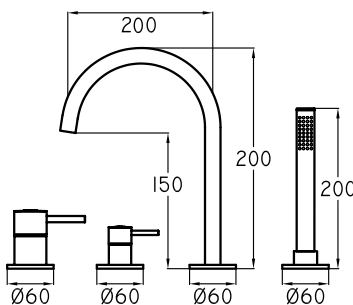

Finitura/finish/finition €

CC-ON 500,00

NS-OP-OL-BO-NO-SE-TE 675,00

NP-TO-FE-TU-CM-CL-NM  
 AN-RU-CO-RO-PO-CE-CN 750,00

OO-OR 1.000,00

## ZC500404

Miscelatore vasca  
*Bath mixer*  
 Mitigeur bain

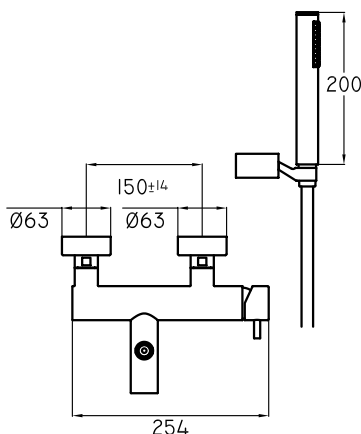

Finitura/finish/finition €

CC-ON 450,00

NS-OP-OL-BO-NO-SE-TE 605,00

NP-TO-FE-TU-CM-CL-NM  
 AN-RU-CO-RO-PO-CE-CN 675,00

OO-OR 900,00

# ZC500405.E

Miscelatore vasca componente esterno

Bath mixer external component

Mitigeur bain composant externe

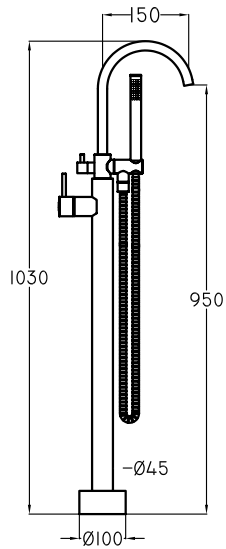

Finitura/finish/finition	€
CC-ON	1.200,00
NS-OP-OL-BO-NO-SE-TE	1.620,00
NP-TO-FE-TU-CM-CL-NM AN-RU-CO-RO-PO-CE-CN	1.800,00
OO-OR	2.400,00

## ZC0D3507GR

Componente incasso

Built-in part

Composant intégré



	€
GR	210,00



## ZC600100

Miscelatore lavabo  
*Basin mixer*  
Mitigeur lavabo

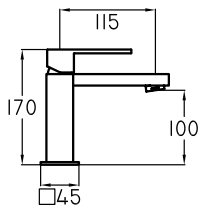

Finitura/finish/finition	€
CC	340,00
NS-NO-BO-SE-TE	460,00
NP-TU-CL-NM AN-RU-CO-PO-CE-CN	510,00
OO-OR	680,00

## ZC600101

Miscelatore lavabo  
*Basin mixer*  
Mitigeur lavabo

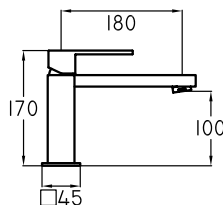

Finitura/finish/finition	€
CC	370,00
NS-NO-BO-SE-TE	500,00
NP-TU-CL-NM AN-RU-CO-PO-CE-CN	555,00
OO-OR	740,00

## ZC600102

Miscelatore lavabo  
*Basin mixer*  
Mitigeur lavabo

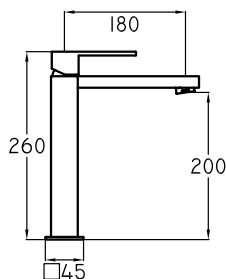

Finitura/finish/finition	€
CC	420,00
NS-NO-BO-SE-TE	570,00
NP-TU-CL-NM AN-RU-CO-PO-CE-CN	630,00
OO-OR	840,00

## ZC600103

Miscelatore lavabo  
*Basin mixer*  
Mitigeur lavabo

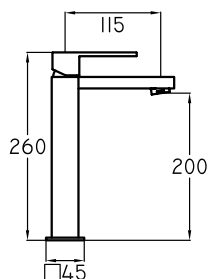

Finitura/finish/finition	€
CC	400,00
NS-NO-BO-SE-TE	540,00
NP-TU-CL-NM AN-RU-CO-PO-CE-CN	600,00
OO-OR	800,00

## ZC600105.E

Miscelatore lavabo componente esterno  
*Basin mixer external component*  
 Mitigeur lavabo composant externe

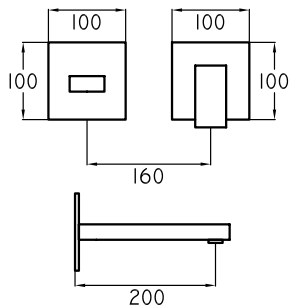
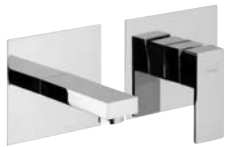

Finitura/finish/finition	€
CC	380,00
NS-NO-BO-SE-TE	515,00
NP-TU-CL-NM AN-RU-CO-PO-CE-CN	570,00
OO-OR	760,00

## ZC0D2502GR

Componente incasso  
*Built-in part*  
 Composant intégré

€

GR 120,00



## ZC0D2502GR.C

Incasso per cartongesso  
*Built-in part for drywall*  
 C. intégré pour cloison sèche

€

GR 150,00



## ZC600200

Miscelatore bidet  
*Bidet mixer*  
 Mitigeur bidet

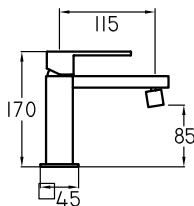

Finitura/finish/finition	€
CC	360,00
NS-NO-BO-SE-TE	490,00
NP-TU-CL-NM AN-RU-CO-PO-CE-CN	540,00
OO-OR	720,00

## ZC600202.E

Miscelatore bidet componente esterno  
*Bidet mixer external component*  
 Mitigeur bidet composant externe

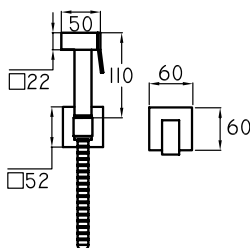

Finitura/finish/finition	€
CC	410,00
NS-NO-BO-SE-TE	555,00
NP-TU-CL-NM AN-RU-CO-PO-CE-CN	615,00
OO-OR	820,00

## ZC0D2501GR

Componente incasso  
*Built-in part*  
 Composant intégré

€

GR 115,00



## ZC0D2501GR.C

Incasso per cartongesso  
*Built-in part for drywall*  
 C. intégré pour cloison sèche

€

GR 145,00





## ZC600300.E

Miscelatore doccia componente esterno  
*Shower mixer external component*  
 Mitigeur douche composant externe

1 outlet

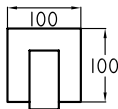

Finitura/finish/finition	€
CC	210,00
NS-NO-BO-SE-TE	285,00
NP-TU-CL-NM AN-RU-CO-PO-CE-CN	315,00
OO-OR	420,00



### ZC0D2503GR

Componente incasso  
*Built-in part*  
 Composant intégré

GR	€
GR	90,00



### ZC0D2503GR.C

Incasso per cartongesso  
*Built-in part for drywall*  
 C. intégré pour cloison sèche

GR	€
GR	120,00

## ZC600301.E

Miscelatore doccia componente esterno  
*Shower mixer external component*  
 Mitigeur douche composant externe

2 outlets

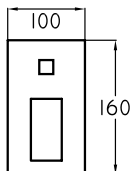

Finitura/finish/finition	€
CC	440,00
NS-NO-BO-SE-TE	600,00
NP-TU-CL-NM AN-RU-CO-PO-CE-CN	660,00
OO-OR	880,00



### ZC0D2507GR

Componente incasso  
*Built-in part*  
 Composant intégré

GR	€
GR	135,00



### ZC0D2507GR.C

Incasso per cartongesso  
*Built-in part for drywall*  
 C. intégré pour cloison sèche

GR	€
GR	165,00

## ZC600302.E

Miscelatore doccia  
 componente esterno  
*Shower mixer  
 external component*  
 Mitigeur douche  
 composant externe

2 outlets

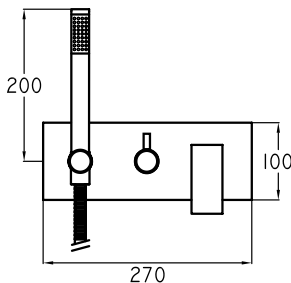

Finitura/finish/finition	€
CC	600,00
NS-NO-BO-SE-TE	810,00
NP-TU-CL-NM AN-RU-CO-PO-CE-CN	900,00
OO-OR	1.200,00



### ZC0D2508GR

Componente incasso  
*Built-in part*  
 Composant intégré

GR	€
GR	200,00



### ZC0D2508GR.C

Incasso per cartongesso  
*Built-in part for drywall*  
 C. intégré pour cloison sèche

GR	€
GR	230,00

## ZC600304.E

Deviatore componente esterno  
*Diverter external component*  
Dèviateur composant externe

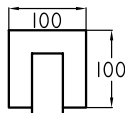

Finitura/finish/finition	€
CC	210,00
NS-NO-BO-SE-TE	285,00
NP-TU-CL-NM AN-RU-CO-PO-CE-CN	315,00
OO-OR	420,00



## ZCODEV01GR

Componente incasso  
*Built-in part*  
Composant intégré

€
GR 120,00

## ZC600401.E

Miscelatore vasca componente esterno  
*Bath mixer external component*  
Mitigeur bain composant externe

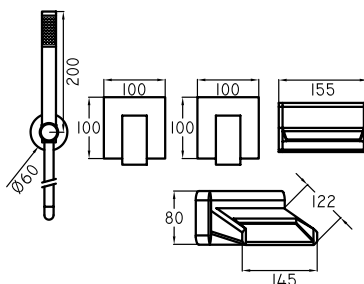

Finitura/finish/finition	€
CC	1.500,00
NS-NO-BO-SE-TE	2.025,00
NP-TU-CL-NM AN-RU-CO-PO-CE-CN	2.250,00
OO-OR	3.000,00



## ZCOD2506GR

Componente incasso  
*Built-in part*  
Composant intégré

€
GR 180,00



## ZCOD2506GR.C

Incasso per cartongesso  
*Built-in part for drywall*  
C. intégré pour cloison sèche

€
GR 240,00



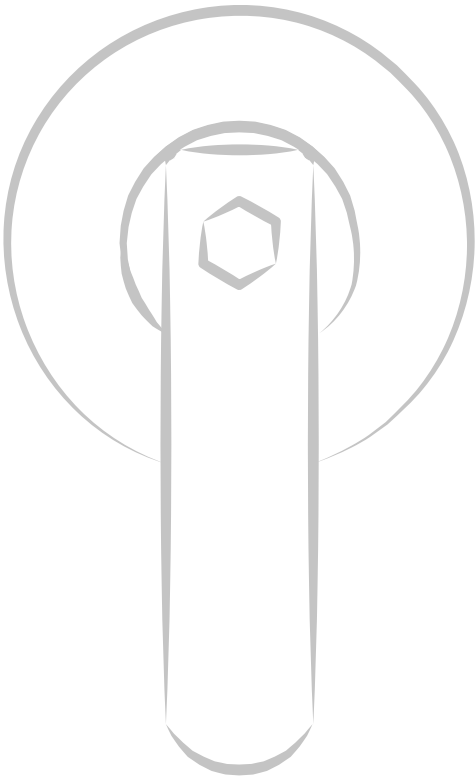
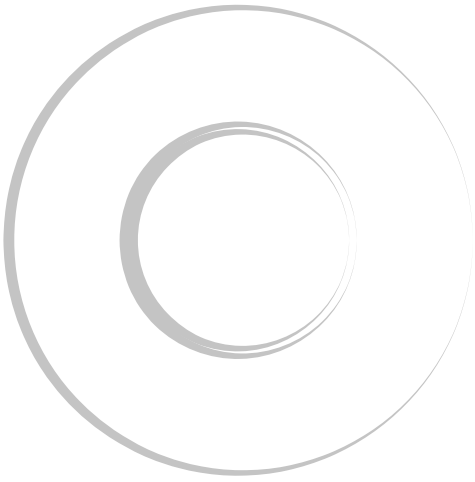

ZC7

## ZC700100

Miscelatore lavabo  
*Basin mixer*  
 Mitigeur lavabo

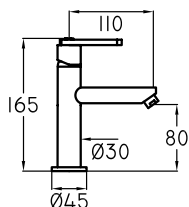

Finitura/finish/finition	€
CC-ON	240,00
NS-OP-OL-BO-NO-SE-TE	325,00
NP-TO-FE-TU-CM-CL-NM AN-RU-CO-RO-PO-CE-CN	360,00
OO-OR	480,00

## ZC700101

Miscelatore lavabo  
*Basin mixer*  
 Mitigeur lavabo

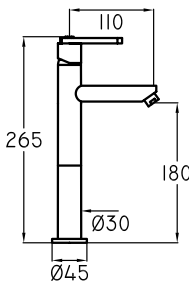

Finitura/finish/finition	€
CC-ON	280,00
NS-OP-OL-BO-NO-SE-TE	380,00
NP-TO-FE-TU-CM-CL-NM AN-RU-CO-RO-PO-CE-CN	420,00
OO-OR	560,00

## ZC700103.E

Miscelatore lavabo componente esterno  
*Basin mixer external component*  
 Mitigeur lavabo composant externe

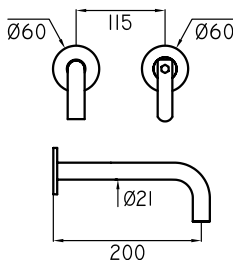

Finitura/finish/finition	€
CC-ON	230,00
NS-OP-OL-BO-NO-SE-TE	310,00
NP-TO-FE-TU-CM-CL-NM AN-RU-CO-RO-PO-CE-CN	345,00
OO-OR	460,00

## ZCOD2501GR

Componente incasso  
*Built-in part*  
 Composant intégré



	€
GR	115,00

## ZCOD2501GR.C

Incasso per cartongesso  
*Built-in part for drywall*  
 C. intégré pour cloison sèche



	€
GR	145,00

## ZC700200

Miscelatore bidet  
Bidet mixer  
Mitigeur bidet

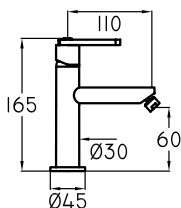

Finitura/finish/finition	€
CC-ON	245,00
NS-OP-OL-BO-NO-SE-TE	330,00
NP-TO-FE-TU-CM-CL-NM AN-RU-CO-RO-PO-CE-CN	365,00
OO-OR	485,00

## ZC700300.E

Miscelatore doccia componente esterno  
Shower mixer external component  
Mitigeur douche composant externe

1 outlet

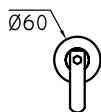

Finitura/finish/finition	€
CC-ON	170,00
NS-OP-OL-BO-NO-SE-TE	230,00
NP-TO-FE-TU-CM-CL-NM AN-RU-CO-RO-PO-CE-CN	255,00
OO-OR	340,00



### ZCOD2503GR

Componente incasso  
Built-in part  
Composant intégré

GR € 90,00



### ZCOD2503GR.C

Incasso per cartongesso  
Built-in part for drywall  
C. intégré pour cloison sèche

GR € 120,00

## ZC700301.E

Miscelatore doccia componente esterno  
Shower mixer external component  
Mitigeur douche composant externe

2 outlets

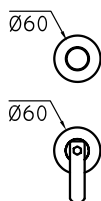

Finitura/finish/finition	€
CC-ON	230,00
NS-OP-OL-BO-NO-SE-TE	310,00
NP-TO-FE-TU-CM-CL-NM AN-RU-CO-RO-PO-CE-CN	345,00
OO-OR	460,00



### ZCOD2504GR

Componente incasso  
Built-in part  
Composant intégré

GR € 145,00



### ZCOD2504GR.C

Incasso per cartongesso  
Built-in part for drywall  
C. intégré pour cloison sèche

GR € 175,00

## ZC700302.E

Miscelatore doccia componente esterno  
 Shower mixer external component  
 Mitigeur douche composant externe

1 outlet

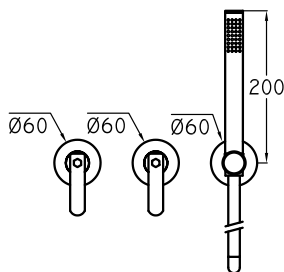

Finitura/finish/finition €

CC-ON 460,00

NS-OP-OL-BO-NO-SE-TE 620,00

NP-TO-FE-TU-CM-CL-NM  
 AN-RU-CO-RO-PO-CE-CN 690,00

OO-OR 920,00



### ZC0D2506GR

Componente incasso  
 Built-in part  
 Composant intégré

€  
 GR 180,00



### ZC0D2506GR.C

Incasso per cartongesso  
 Built-in part for drywall  
 C. intégré pour cloison sèche

€  
 GR 240,00

## ZC700303.E

Deviatore componente esterno  
 Diverter external component  
 Déviateur composant externe

3 outlets

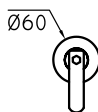

Finitura/finish/finition €

CC-ON 170,00

NS-OP-OL-BO-NO-SE-TE 230,00

NP-TO-FE-TU-CM-CL-NM  
 AN-RU-CO-RO-PO-CE-CN 255,00

OO-OR 340,00



### ZC0DEV01GR

Componente incasso  
 Built-in part  
 Composant intégré

€  
 GR 120,00

## ZC700400.E

Miscelatore vasca  
 componente esterno  
 Bath mixer external component  
 Mitigeur bain composant externe

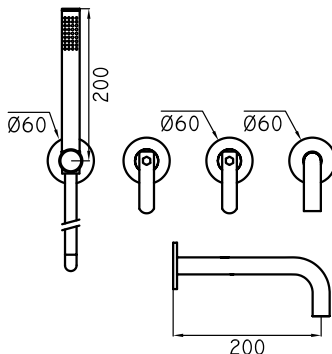

Finitura/finish/finition €

CC-ON 600,00

NS-OP-OL-BO-NO-SE-TE 810,00

NP-TO-FE-TU-CM-CL-NM  
 AN-RU-CO-RO-PO-CE-CN 900,00

OO-OR 1.200,00



### ZC0D2506GR

Componente incasso  
 Built-in part  
 Composant intégré

€  
 GR 180,00



### ZC0D2506GR.C

Incasso per cartongesso  
 Built-in part for drywall  
 C. intégré pour cloison sèche

€  
 GR 240,00



ZC8



## ZC800100

Rubinetto lavabo  
Basin tap  
Mélangeur lavabo

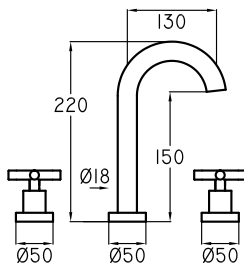

Finitura/finish/finition	€
CC-ON	330,00
NS-OP-OL-BO-NO-SE-TE	445,00
NP-TO-FE-TU-CM-CL-NM AN-RU-CO-RO-PO-CE-CN	495,00
OO-OR	660,00

## ZC800101

Rubinetto lavabo  
Basin tap  
Mélangeur lavabo

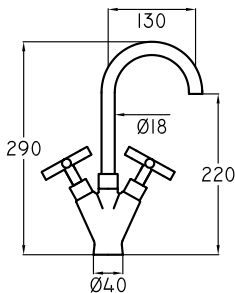

Finitura/finish/finition	€
CC-ON	330,00
NS-OP-OL-BO-NO-SE-TE	445,00
NP-TO-FE-TU-CM-CL-NM AN-RU-CO-RO-PO-CE-CN	495,00
OO-OR	660,00

## ZC800102.E

Rubinetto lavabo componente esterno  
Basin tap external component  
Mélangeur lavabo composant externe

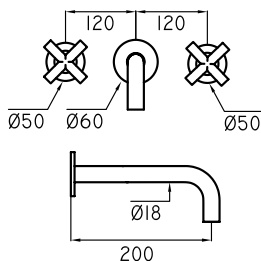

Finitura/finish/finition	€
CC-ON	300,00
NS-OP-OL-BO-NO-SE-TE	405,00
NP-TO-FE-TU-CM-CL-NM AN-RU-CO-RO-PO-CE-CN	450,00
OO-OR	600,00

## ZC0TRC01GR

Componente incasso  
Built-in part  
Composant intégré



GR	€
GR	140,00

## ZC0TRC01GR.C

Incasso per cartongesso  
Built-in part for drywall  
C. intégré pour cloison sèche



GR	€
GR	170,00

## ZC800103.E

Rubinetto lavabo componente esterno  
*Basin tap external component*  
 Mélangeur lavabo composant externe

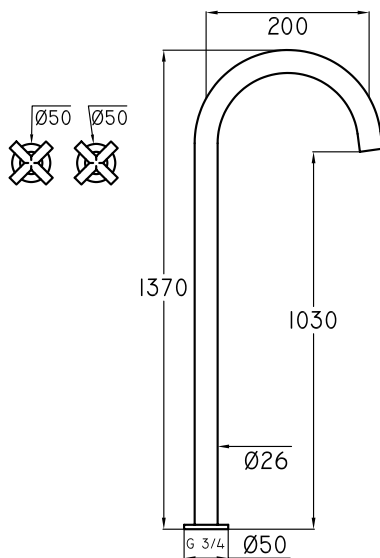
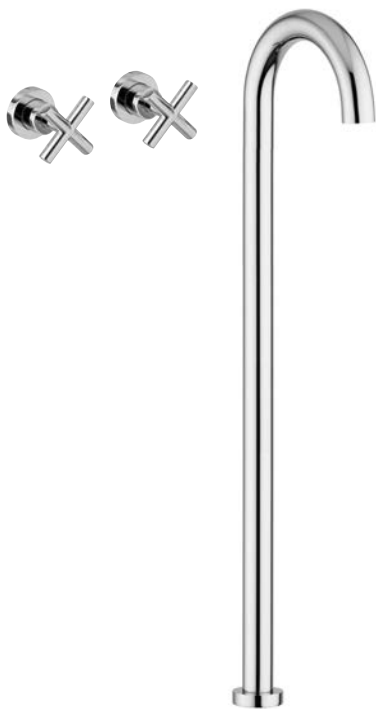

Finitura/finish/finition	€
CC-ON	610,00
NS-OP-OL-BO-NO-SE-TE	825,00
NP-TO-FE-TU-CM-CL-NM AN-RU-CO-RO-PO-CE-CN	915,00
OO-OR	1.220,00



## ZC0TRC03GR

Componente incasso  
*Built-in part*  
 Composant intégré

	€
GR	100,00

## ZC800200

Rubinetto bidet  
*Bidet tap*  
 Mélangeur bidet

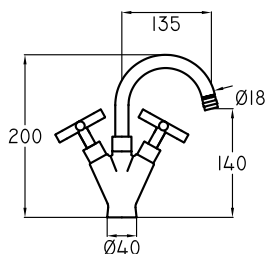

Finitura/finish/finition	€
CC-ON	330,00
NS-OP-OL-BO-NO-SE-TE	445,00
NP-TO-FE-TU-CM-CL-NM AN-RU-CO-RO-PO-CE-CN	495,00
OO-OR	660,00

## ZC800300.E

Rubinetto doccia componente esterno  
*Shower tap external component*  
 Mélangeur douche composant externe

1 outlet

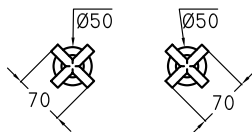

Finitura/finish/finition €

CC-ON 200,00

NS-OP-OL-BO-NO-SE-TE 270,00

NP-TO-FE-TU-CM-CL-NM  
 AN-RU-CO-RO-PO-CE-CN 300,00

OO-OR 400,00

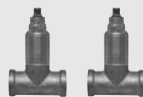

## ZC0TRC03GR

Componente incasso  
*Built-in part*  
 Composant intégré

GR € 100,00

## ZC800301.E

Rubinetto doccia componente esterno  
*Shower tap external component*  
 Mélangeur douche composant externe

1 outlet

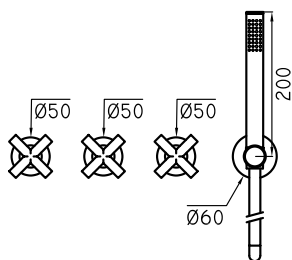
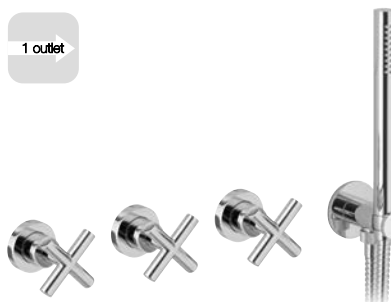

Finitura/finish/finition €

CC-ON 500,00

NS-OP-OL-BO-NO-SE-TE 675,00

NP-TO-FE-TU-CM-CL-NM  
 AN-RU-CO-RO-PO-CE-CN 750,00

OO-OR 1.000,00



## ZC0TRC04GR

Componente incasso  
*Built-in part*  
 Composant intégré

GR € 200,00



## ZC0TRC04GR.C

Incasso per cartongesso  
*Built-in part for drywall*  
 C. intégré pour cloison sèche

GR € 230,00

## ZC800302.E

Deviatore componente esterno  
*Diverter external component*  
 Dèviateur composant externe

3 outlets

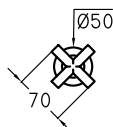

Finitura/finish/finition €

CC-ON 100,00

NS-OP-OL-BO-NO-SE-TE 135,00

NP-TO-FE-TU-CM-CL-NM  
 AN-RU-CO-RO-PO-CE-CN 150,00

OO-OR 200,00



## ZC0DEV01GR

Componente incasso  
*Built-in part*  
 Composant intégré

GR € 120,00

## ZC800303.E

Rubinetto d'arresto componente esterno  
*Stop cock external component*  
 Robinet d'arret composant externe

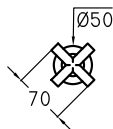

Finitura/finish/finition	€
CC-ON	100,00
NS-OP-OL-BO-NO-SE-TE	135,00
NP-TO-FE-TU-CM-CL-NM AN-RU-CO-RO-PO-CE-CN	150,00
OO-OR	200,00



## ZC0TRC02GR

Componente incasso  
*Built-in part*  
 Composant intégré

GR	€
	50,00

## ZC800401.E

Rubinetto vasca componente esterno  
*Bath tap external component*  
 Mélangeur bain composant externe

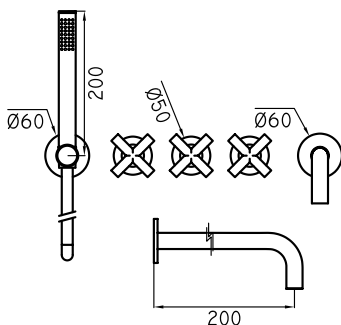

Finitura/finish/finition	€
CC-ON	650,00
NS-OP-OL-BO-NO-SE-TE	875,00
NP-TO-FE-TU-CM-CL-NM AN-RU-CO-RO-PO-CE-CN	975,00
OO-OR	1.300,00



## ZC0TRC04GR

Componente incasso  
*Built-in part*  
 Composant intégré

GR	€
	200,00



## ZC0TRC04GR.C

Incasso per cartongesso  
*Built-in part for drywall*  
 C. intégré pour cloison sèche

GR	€
	230,00

## ZC800402

Rubinetto vasca  
*Bath tap*  
 Mélangeur bain

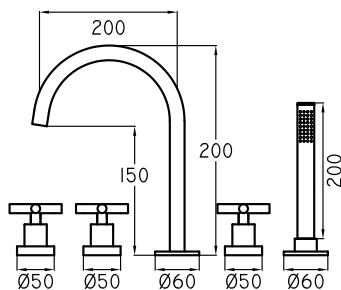

Finitura/finish/finition	€
CC-ON	920,00
NS-OP-OL-BO-NO-SE-TE	1.245,00
NP-TO-FE-TU-CM-CL-NM AN-RU-CO-RO-PO-CE-CN	1.380,00
OO-OR	1.840,00



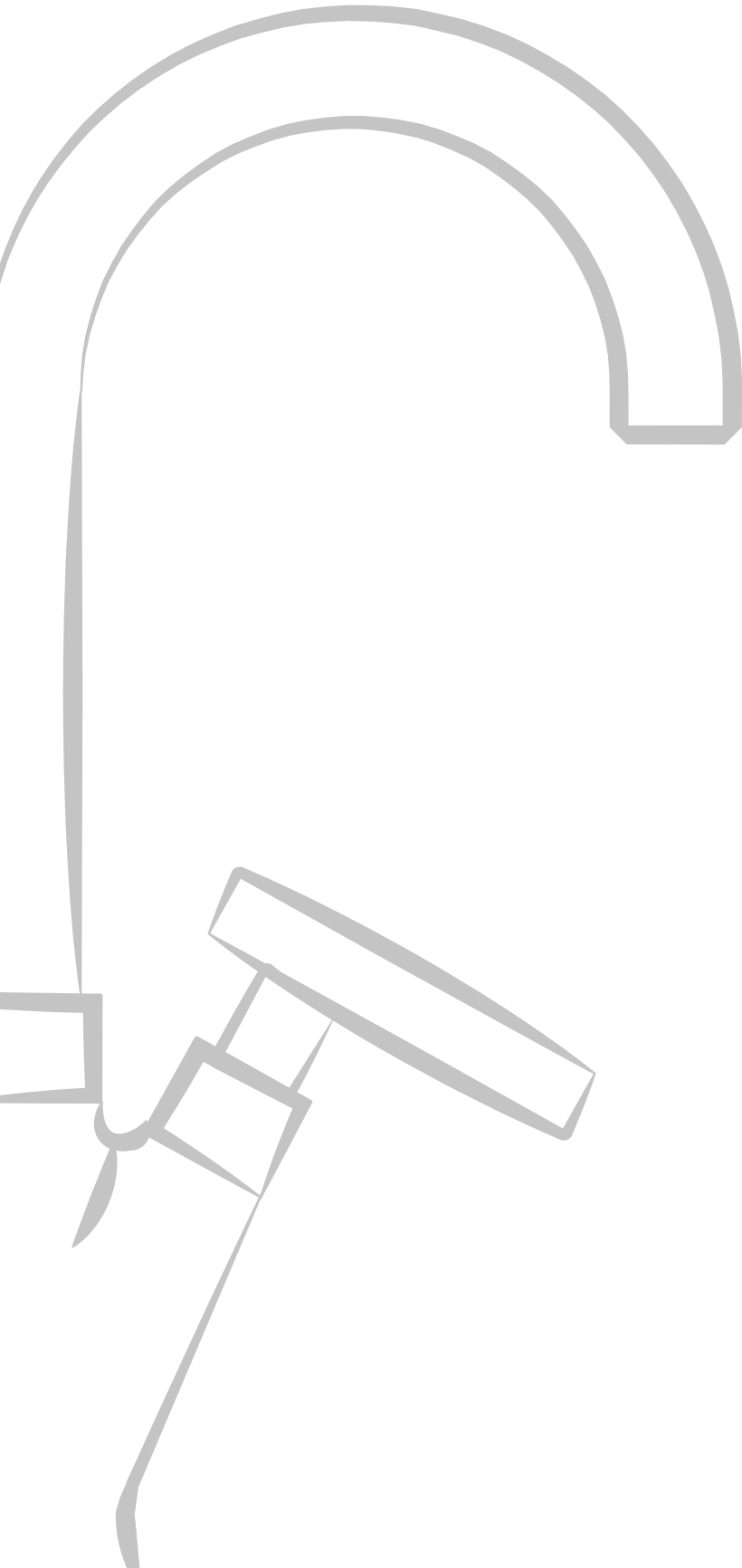

ZC9

## ZC900100

Rubinetto lavabo  
Basin tap  
Mélangeur lavabo

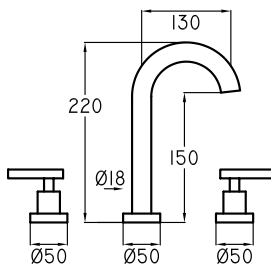

Finitura/finish/finition	€
CC-ON	330,00
NS-OP-OL-BO-NO-SE-TE	445,00
NP-TO-FE-TU-CM-CL-NM AN-RU-CO-RO-PO-CE-CN	495,00
OO-OR	660,00

## ZC900101

Rubinetto lavabo  
Basin tap  
Mélangeur lavabo

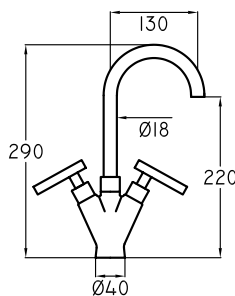

Finitura/finish/finition	€
CC-ON	330,00
NS-OP-OL-BO-NO-SE-TE	445,00
NP-TO-FE-TU-CM-CL-NM AN-RU-CO-RO-PO-CE-CN	495,00
OO-OR	660,00

## ZC900102.E

Rubinetto lavabo componente esterno  
Basin tap external component  
Mélangeur lavabo composant externe

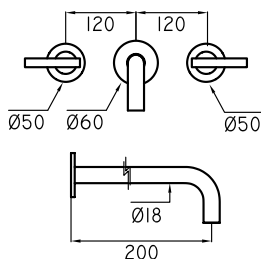

Finitura/finish/finition	€
CC-ON	300,00
NS-OP-OL-BO-NO-SE-TE	405,00
NP-TO-FE-TU-CM-CL-NM AN-RU-CO-RO-PO-CE-CN	450,00
OO-OR	600,00

## ZC0TRC05GR

Componente incasso  
Built-in part  
Composant intégré



GR € 140,00

## ZC0TRC05GR.C

Incasso per cartongesso  
Built-in part for drywall  
C. intégré pour cloison sèche



GR € 170,00

## ZC900103.E

Rubinetto lavabo componente esterno  
*Basin tap external component*  
 Mélangeur lavabo composant externe

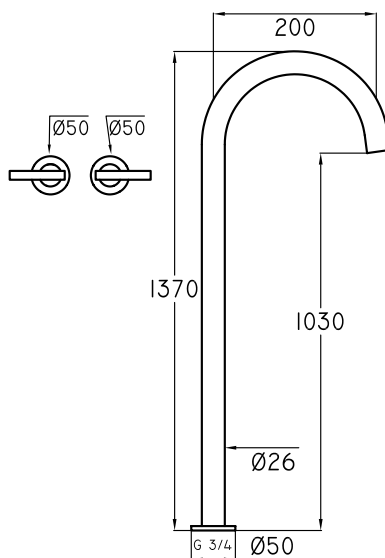

Finitura/finish/finition	€
CC-ON	610,00
NS-OP-OL-BO-NO-SE-TE	825,00
NP-TO-FE-TU-CM-CL-NM AN-RU-CO-RO-PO-CE-CN	915,00
OO-OR	1.220,00



## ZC0TRC07GR

Componente incasso  
*Built-in part*  
 Composant intégré

	€
GR	100,00

## ZC900200

Rubinetto bidet  
*Bidet tap*  
 Mélangeur bidet

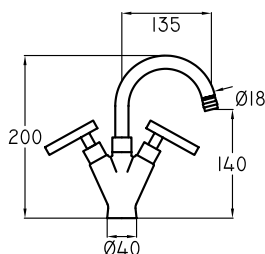

Finitura/finish/finition	€
CC-ON	330,00
NS-OP-OL-BO-NO-SE-TE	445,00
NP-TO-FE-TU-CM-CL-NM AN-RU-CO-RO-PO-CE-CN	495,00
OO-OR	660,00



## ZC900300.E

Rubinetto doccia componente esterno  
*Shower tap external component*  
 Mélangeur douche composant externe

1 outlet

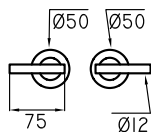

Finitura/finish/finition	€
CC-ON	200,00
NS-OP-OL-BO-NO-SE-TE	270,00
NP-TO-FE-TU-CM-CL-NM AN-RU-CO-RO-PO-CE-CN	300,00
OO-OR	400,00



## ZC0TRC07GR

Componente incasso  
*Built-in part*  
 Composant intégré

GR € 100,00

## ZC900301.E

Rubinetto doccia componente esterno  
*Shower tap external component*  
 Mélangeur douche composant externe

1 outlet

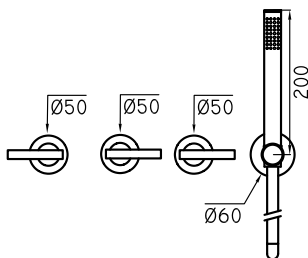

Finitura/finish/finition	€
CC-ON	500,00
NS-OP-OL-BO-NO-SE-TE	675,00
NP-TO-FE-TU-CM-CL-NM AN-RU-CO-RO-PO-CE-CN	750,00
OO-OR	1.000,00



## ZC0TRC08GR

Componente incasso  
*Built-in part*  
 Composant intégré

GR € 200,00



## ZC0TRC08GR.C

Incasso per cartongesso  
*Built-in part for drywall*  
 C. intégré pour cloison sèche

GR € 230,00

## ZC900304.E

Deviatore componente esterno  
*Diverter external component*  
 Dèviateur composant externe

3 outlets



Finitura/finish/finition	€
CC-ON	100,00
NS-OP-OL-BO-NO-SE-TE	135,00
NP-TO-FE-TU-CM-CL-NM AN-RU-CO-RO-PO-CE-CN	150,00
OO-OR	200,00



## ZC0DEV01GR

Componente incasso  
*Built-in part*  
 Composant intégré

GR € 120,00

## ZC900305.E

Rubinetto d'arresto componente esterno  
*Stop cock external component*  
 Robinet d'arret composant externe



Finitura/finish/finition	€
CC-ON	100,00
NS-OP-OL-BO-NO-SE-TE	135,00
NP-TO-FE-TU-CM-CL-NM AN-RU-CO-RO-PO-CE-CN	150,00
OO-OR	200,00



## ZC0TRC06GR

Componente incasso  
*Built-in part*  
 Composant intégré

GR	€
	50,00

## ZC900401.E

Rubinetto vasca componente esterno  
*Bath tap external component*  
 Mélangeur bain composant externe

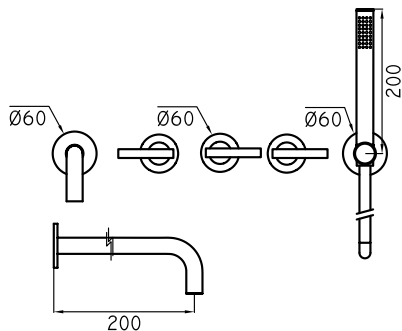

Finitura/finish/finition	€
CC-ON	650,00
NS-OP-OL-BO-NO-SE-TE	880,00
NP-TO-FE-TU-CM-CL-NM AN-RU-CO-RO-PO-CE-CN	975,00
OO-OR	1.300,00



## ZC0TRC08GR

Componente incasso  
*Built-in part*  
 Composant intégré

GR	€
	200,00



## ZC0TRC08GR.C

Incasso per cartongesso  
*Built-in part for drywall*  
 C. intégré pour cloison sèche

GR	€
	230,00

## ZC900402

Rubinetto vasca  
*Bath tap*  
 Mélangeur bain

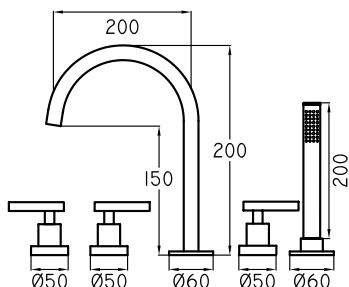

Finitura/finish/finition	€
CC-ON	920,00
NS-OP-OL-BO-NO-SE-TE	1.240,00
NP-TO-FE-TU-CM-CL-NM AN-RU-CO-RO-PO-CE-CN	1.380,00
OO-OR	1.840,00





ZC11

## ZC110100

Miscelatore lavabo  
Basin mixer  
Mitigeur lavabo

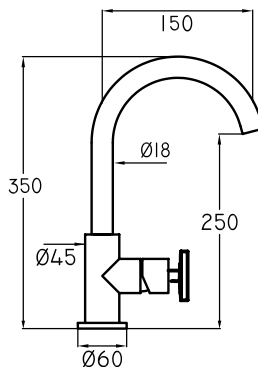

Finitura/finish/finition	€
CC-ON	290,00
NS-OP-OL-BO-NO-SE-TE	390,00
NP-TO-FE-TU-CM-CL-NM AN-RU-CO-RO-PO-CE-CN	435,00
OO-OR	580,00

## ZC110101.E

Miscelatore lavabo componente esterno  
Basin mixer external component  
Mitigeur lavabo composant externe

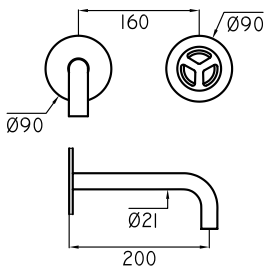

Finitura/finish/finition	€
CC-ON	290,00
NS-OP-OL-BO-NO-SE-TE	390,00
NP-TO-FE-TU-CM-CL-NM AN-RU-CO-RO-PO-CE-CN	435,00
OO-OR	580,00



### ZC0D3502GR

Componente incasso  
Built-in part  
Composant intégré

	€
GR	120,00



### ZC0D3502GR.C

Incasso per cartongesso  
Built-in part for drywall  
C. intégré pour cloison sèche

	€
GR	150,00

## ZC110104

Rubinetto lavabo  
Basin tap  
Mélangeur lavabo

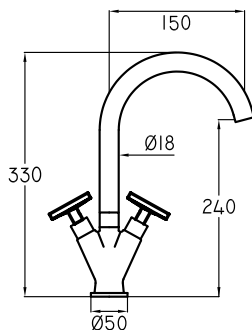

Finitura/finish/finition	€
CC-ON	320,00
NS-OP-OL-BO-NO-SE-TE	435,00
NP-TO-FE-TU-CM-CL-NM AN-RU-CO-RO-PO-CE-CN	480,00
OO-OR	640,00

## ZC110105.E

Rubinetto lavabo componente esterno  
*Basin tap external component*  
 Mélangeur lavabo composant externe

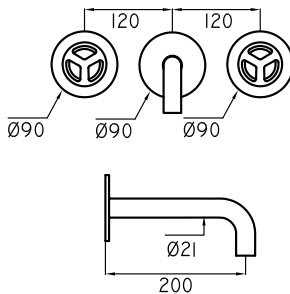

Finitura/finish/finition €

CC-ON 520,00

NS-OP-OL-BO-NO-SE-TE 700,00

NP-TO-FE-TU-CM-CL-NM  
 AN-RU-CO-RO-PO-CE-CN 780,00

OO-OR 1.040,00

## ZC0TRC01GR

Componente incasso  
*Built-in part*  
 Composant intégré



GR 140,00



## ZC0TRC01GR.C

Incasso per cartongesso  
*Built-in part for drywall*  
 C. intégré pour cloison sèche

GR 170,00

## ZC110106

Rubinetto lavabo  
*Basin tap*  
 Mélangeur lavabo

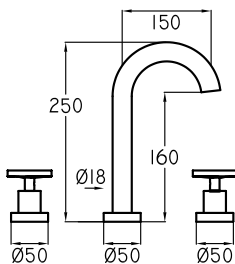

Finitura/finish/finition €

CC-ON 520,00

NS-OP-OL-BO-NO-SE-TE 700,00

NP-TO-FE-TU-CM-CL-NM  
 AN-RU-CO-RO-PO-CE-CN 780,00

OO-OR 1.040,00

## ZC110200

Miscelatore bidet  
*Bidet mixer*  
 Mitigeur bidet

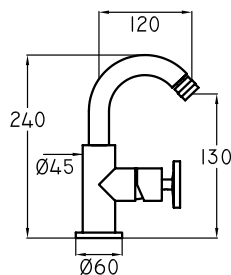

Finitura/finish/finition €

CC-ON 290,00

NS-OP-OL-BO-NO-SE-TE 390,00

NP-TO-FE-TU-CM-CL-NM  
 AN-RU-CO-RO-PO-CE-CN 435,00

OO-OR 580,00

## ZC110201

Rubinetto bidet  
Bidet tap  
Mélangeur bidet

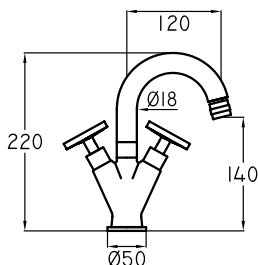

Finitura/finish/finition	€
CC-ON	320,00
NS-OP-OL-BO-NO-SE-TE	435,00
NP-TO-FE-TU-CM-CL-NM AN-RU-CO-RO-PO-CE-CN	480,00
OO-OR	640,00

## ZC110300.E

Miscelatore doccia componente esterno  
Shower mixer external component  
Mitigeur douche composant externe

1 outlet

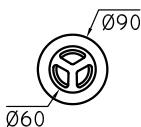

Finitura/finish/finition	€
CC-ON	250,00
NS-OP-OL-BO-NO-SE-TE	340,00
NP-TO-FE-TU-CM-CL-NM AN-RU-CO-RO-PO-CE-CN	375,00
OO-OR	500,00



### ZCOD3503GR

Componente incasso  
Built-in part  
Composant intégré

GR	€
	90,00



### ZCOD3503GR.C

Incasso per cartongesso  
Built-in part for drywall  
C. intégré pour cloison sèche

GR	€
	120,00

## ZC110301.E

Miscelatore doccia componente esterno  
Shower mixer external component  
Mitigeur douche composant externe

2 outlets

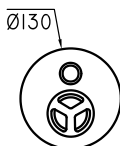

Finitura/finish/finition	€
CC-ON	330,00
NS-OP-OL-BO-NO-SE-TE	445,00
NP-TO-FE-TU-CM-CL-NM AN-RU-CO-RO-PO-CE-CN	495,00
OO-OR	660,00



### ZCOD3504GR

Componente incasso  
Built-in part  
Composant intégré

GR	€
	135,00



### ZCOD3504GR.C

Incasso per cartongesso  
Built-in part for drywall  
C. intégré pour cloison sèche

GR	€
	165,00

## ZC110302.E

Miscelatore doccia componente esterno  
 Shower mixer external component  
 Mitigeur douche composant externe

1 outlet

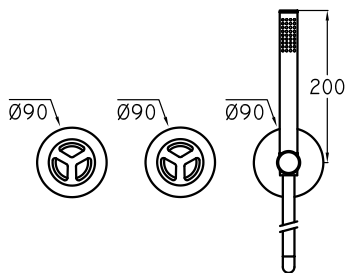
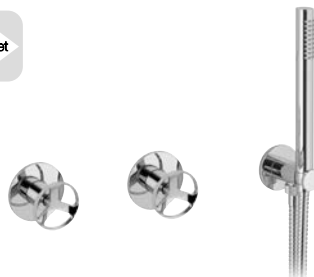

Finitura/finish/finition €

CC-ON 610,00

NS-OP-OL-BO-NO-SE-TE 825,00

NP-TO-FE-TU-CM-CL-NM  
 AN-RU-CO-RO-PO-CE-CN 915,00

OO-OR 1.220,00



## ZC0D3508GR

Componente incasso  
 Built-in part  
 Composant intégré

GR 180,00



## ZC0D3508GR.C

Incasso per cartongesso  
 Built-in part for drywall  
 C. intégré pour cloison sèche

GR 240,00

## ZC110303.E

Deviatore doccia componente esterno  
 Shower diverter external component  
 Déviateur douche composant externe

3 outlets

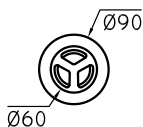

Finitura/finish/finition €

CC-ON 250,00

NS-OP-OL-BO-NO-SE-TE 340,00

NP-TO-FE-TU-CM-CL-NM  
 AN-RU-CO-RO-PO-CE-CN 375,00

OO-OR 500,00



## ZC0DEV01GR

Componente incasso  
 Built-in part  
 Composant intégré

GR 120,00

## ZC110400

Rubinetto vasca  
 Bath tap  
 Mélangeur bain

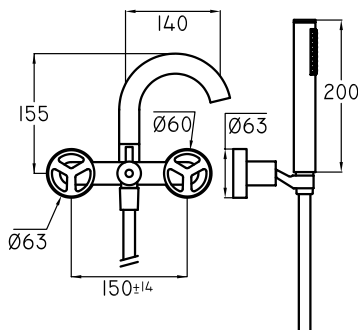

Finitura/finish/finition €

CC-ON 710,00

NS-OP-OL-BO-NO-SE-TE 950,00

NP-TO-FE-TU-CM-CL-NM  
 AN-RU-CO-RO-PO-CE-CN 1.065,00

OO-OR 1.420,00



# ZC110401.E

Miscelatore vasca componente esterno  
*Bath mixer external component*  
 Mitigeur bain composant externe

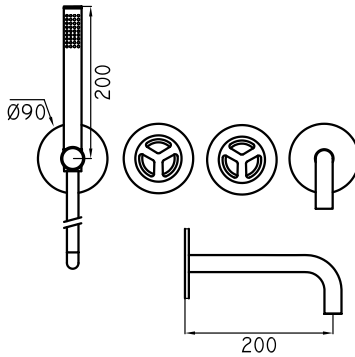
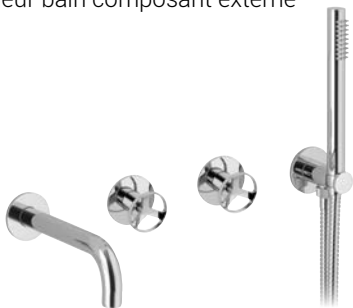

Finitura/finish/finition	€
CC-ON	690,00
NS-OP-OL-BO-NO-SE-TE	930,00
NP-TO-FE-TU-CM-CL-NM AN-RU-CO-RO-PO-CE-CN	1.035,00
OO-OR	1.380,00



## ZC0D3508GR

Componente incasso  
*Built-in part*  
 Composant intégré

	€
GR	180,00



## ZC0D3508GR.C

Incasso per cartongesso  
*Built-in part for drywall*  
 C. intégré pour cloison sèche

	€
GR	240,00



ZC21  
ZC22  
ZC23

38°

## ZC210300

Doccia termostatica  
Thermostatic shower  
Thermostatique douche

1 outlet

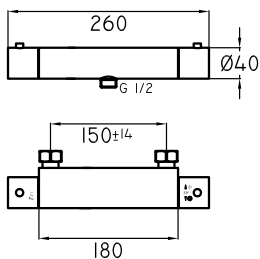

Finitura/finish/finition	€
CC	426,00
NS-BO-NO-SE-TE	575,00
NP-TU-CL-NM AN-RU-CO-PO-CE-CN	640,00
OO-OR	660,00

## ZC210301

Doccia termostatica  
Thermostatic shower  
Thermostatique douche

1 outlet

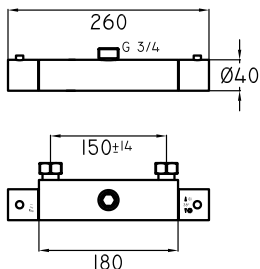

Finitura/finish/finition	€
CC	426,00
NS-BO-NO-SE-TE	575,00
NP-TU-CL-NM AN-RU-CO-PO-CE-CN	640,00
OO-OR	660,00

## ZC210302

Doccia termostatica  
Thermostatic shower  
Thermostatique douche

2 outlets

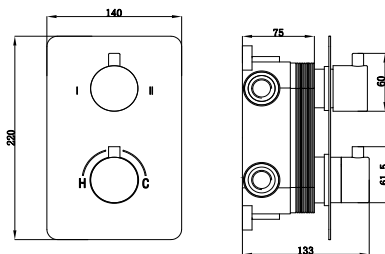

Finitura/finish/finition	€
CC	850,00
NS-BO-NO-SE-TE	1.100,00
NP-TU-CL-NM AN-RU-CO-PO-CE-CN	1.500,00
OO-OR	1.700,00

## ZC210303

Doccia termostatica  
Thermostatic shower  
Thermostatique douche

3 outlets

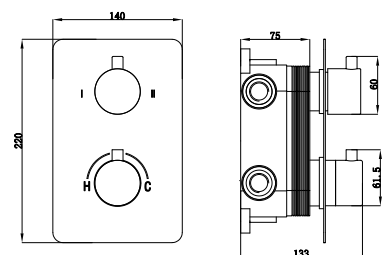

Finitura/finish/finition	€
CC	1.010,00
NS-BO-NO-SE-TE	1.300,00
NP-TU-CL-NM AN-RU-CO-PO-CE-CN	1.800,00
OO-OR	2.020,00

## ZC220300

Doccia termostatica  
Thermostatic shower  
Thermostatique douche

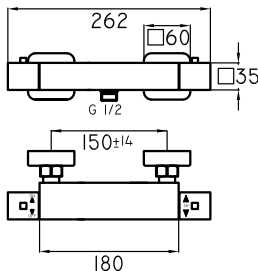

Finitura/finish/finition	€
CC	580,00
NS-BO-NO-SE-TE	785,00
NP-TU-CL-NM AN-RU-CO-PO-CE-CN	870,00
OO-OR	1.160,00

## ZC220301

Doccia termostatica  
Thermostatic shower  
Thermostatique douche

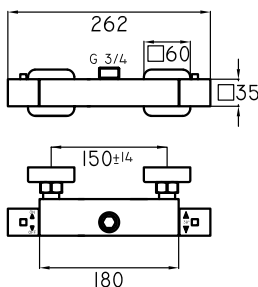
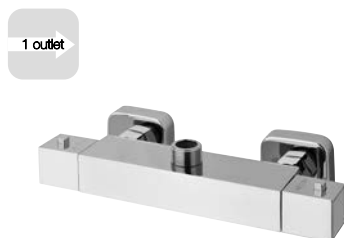

Finitura/finish/finition	€
CC	580,00
NS-BO-NO-SE-TE	785,00
NP-TU-CL-NM AN-RU-CO-PO-CE-CN	870,00
OO-OR	1.160,00

## ZC220302

Doccia termostatica  
Thermostatic shower  
Thermostatique douche

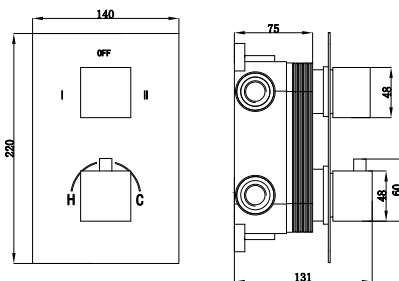

Finitura/finish/finition	€
CC	1.100,00
NS-BO-NO-SE-TE	1.390,00
NP-TU-CL-NM AN-RU-CO-PO-CE-CN	1.820,00
OO-OR	2.200,00

## ZC220303

Doccia termostatica  
Thermostatic shower  
Thermostatique douche

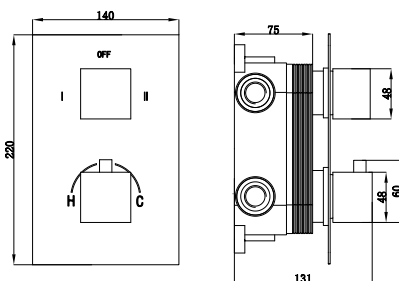

Finitura/finish/finition	€
CC	1.260,00
NS-BO-NO-SE-TE	1.550,00
NP-TU-CL-NM AN-RU-CO-PO-CE-CN	1.980,00
OO-OR	2.520,00

## ZC230100

Rubinetto elettronico a fotocellula con batteria  
*Electronic basin tap battery operated*  
Robinet électronique lavabo alimenté par batterie

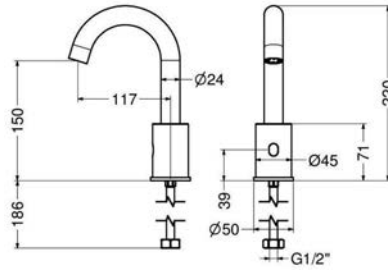

Finitura/finish/finition

€

CC-ON	345,00
NS-OP-OL-BO-NO-SE-TE	450,50
NP-TO-FE-TU-CM-CL-NM AN-RU-CO-RO-PO-CE-CN	550,00
OO-OR	700,00

## ZC230101

Rubinetto elettronico a fotocellula con batteria  
*Electronic basin tap battery operated*  
Robinet électronique lavabo alimenté par batterie

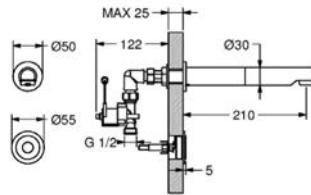

Finitura/finish/finition

€

CC-ON	470,00
NS-OP-OL-BO-NO-SE-TE	610,00
NP-TO-FE-TU-CM-CL-NM AN-RU-CO-RO-PO-CE-CN	740,00
OO-OR	940,00

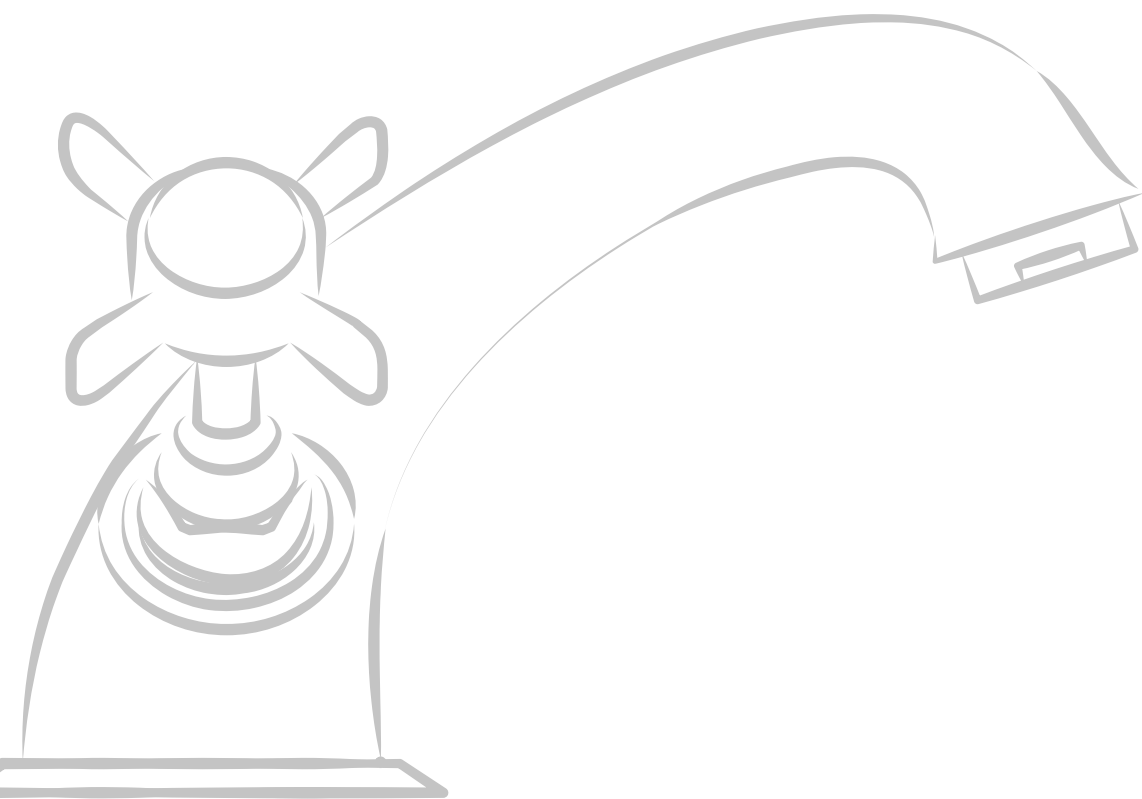

ZC31

## ZC310100

Rubinetto lavabo con scarico 1" 1/4  
*Basin tap with 1" 1/4 pop-up waste*  
 Robinet lavabo avec vidage 1" 1/4

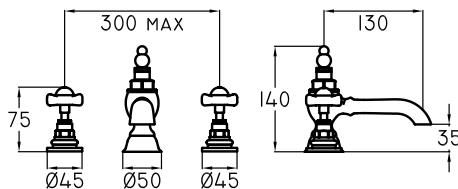

Finitura/finish/finition	€
CC-ON	390,00
NS-OP-OL-BO-NO-SE-TE	525,00
NP-TO-FE-TU-CM-CL-NM AN-RU-CO-RO-PO-CE-CN	585,00
OO-OR	780,00

## ZC310101

Rubinetto lavabo con scarico 1" 1/4  
*Basin tap with 1" 1/4 pop-up waste*  
 Robinet lavabo avec vidage 1" 1/4

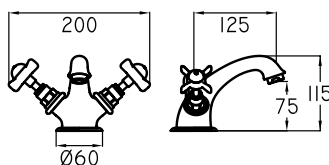

Finitura/finish/finition	€
CC-ON	350,00
NS-OP-OL-BO-NO-SE-TE	470,00
NP-TO-FE-TU-CM-CL-NM AN-RU-CO-RO-PO-CE-CN	525,00
OO-OR	700,00

## ZC310102

Rubinetto lavabo con scarico 1" 1/4  
*Basin tap with 1" 1/4 pop-up waste*  
 Robinet lavabo avec vidage 1" 1/4

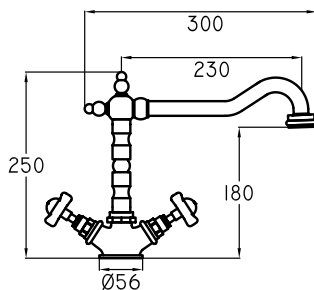

Finitura/finish/finition	€
CC-ON	350,00
NS-OP-OL-BO-NO-SE-TE	470,00
NP-TO-FE-TU-CM-CL-NM AN-RU-CO-RO-PO-CE-CN	525,00
OO-OR	700,00

## ZC310103

Rubinetto lavabo  
*Basin tap*  
 Robinet lavabo

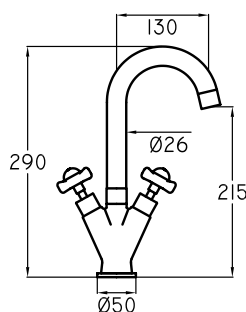

Finitura/finish/finition	€
CC-ON	350,00
NS-OP-OL-BO-NO-SE-TE	470,00
NP-TO-FE-TU-CM-CL-NM AN-RU-CO-RO-PO-CE-CN	525,00
OO-OR	700,00

## ZC310104.E

Rubinetto lavabo componente esterno  
*Basin tap external component*  
 Mélangeur lavabo composant externe

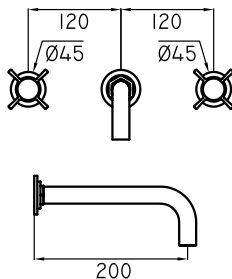

Finitura/finish/finition	€
CC-ON	300,00
NS-OP-OL-BO-NO-SE-TE	405,00
NP-TO-FE-TU-CM-CL-NM AN-RU-CO-RO-PO-CE-CN	450,00
OO-OR	600,00

## ZC0TRC01GR

Componente incasso  
*Built-in part*  
 Composant intégré



GR 140,00

## ZC0TRC01GR.C

Incasso per cartongesso  
*Built-in part for drywall*  
 C. intégré pour cloison sèche



GR 170,00

## ZC310105.E

Rubinetto lavabo  
*Basin tap*  
 Robinet lavabo

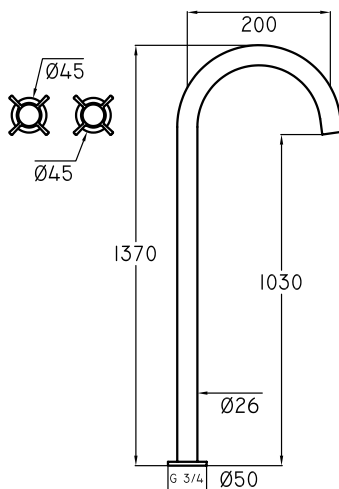

Finitura/finish/finition	€
CC-ON	620,00
NS-OP-OL-BO-NO-SE-TE	825,00
NP-TO-FE-TU-CM-CL-NM AN-RU-CO-RO-PO-CE-CN	915,00
OO-OR	1.220,00

## ZC0TRC03GR

Componente incasso  
*Built-in part*  
 Composant intégré



GR 100,00

## ZC310200

Rubinetto bidet con scarico 1" 1/4  
*Bidet tap with 1" 1/4 pop-up waste*  
 Robinet bidet avec vidage 1" 1/4

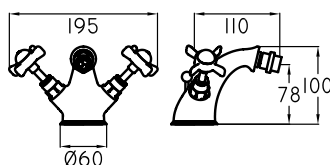

Finitura/finish/finition	€
CC-ON	350,00
NS-OP-OL-BO-NO-SE-TE	470,00
NP-TO-FE-TU-CM-CL-NM AN-RU-CO-RO-PO-CE-CN	525,00
OO-OR	700,00



## ZC310201

Rubinetto bidet con scarico 1" 1/4  
 Bidet tap with 1" 1/4 pop-up waste  
 Robinet bidet avec vidage 1" 1/4

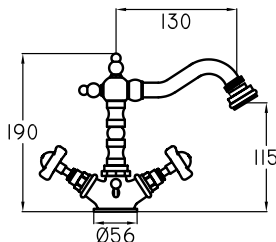

Finitura/finish/finition	€
CC-ON	350,00
NS-OP-OL-BO-NO-SE-TE	470,00
NP-TO-FE-TU-CM-CL-NM AN-RU-CO-RO-PO-CE-CN	525,00
OO-OR	700,00

## ZC310300

Rubinetto doccia  
 Shower tap  
 Mélangeur douche

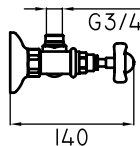
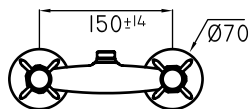

Finitura/finish/finition	€
CC-ON	350,00
NS-OP-OL-BO-NO-SE-TE	470,00
NP-TO-FE-TU-CM-CL-NM AN-RU-CO-RO-PO-CE-CN	525,00
OO-OR	700,00

## ZC310301.E

Rubinetto doccia componente esterno  
 Shower tap external component  
 Mélangeur douche composant externe

1 outlet

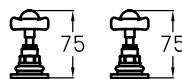
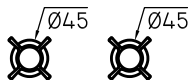

Finitura/finish/finition	€
CC-ON	200,00
NS-OP-OL-BO-NO-SE-TE	270,00
NP-TO-FE-TU-CM-CL-NM AN-RU-CO-RO-PO-CE-CN	300,00
OO-OR	400,00

## ZC0TRC03GR

Componente incasso  
 Built-in part  
 Composant intégré



GR 100,00

## ZC310302.E

Rubinetto doccia componente esterno  
*Shower tap external component*  
 Mélangeur douche composant externe

1 outlet

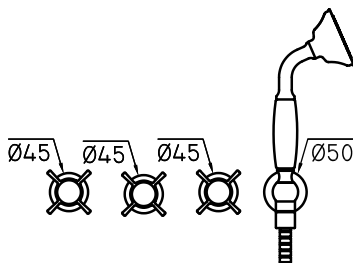

Finitura/finish/finition €

CC-ON 550,00

NS-OP-OL-BO-NO-SE-TE 740,00

NP-TO-FE-TU-CM-CL-NM  
 AN-RU-CO-RO-PO-CE-CN 825,00

OO-OR 1.100,00

## ZC0TRC04GR

Componente incasso  
*Built-in part*  
 Composant intégré



GR 200,00



## ZC0TRC04GR.C

Incasso per cartongesso  
*Built-in part for drywall*  
 C. intégré pour cloison sèche

GR 230,00

## ZC310303.E

Deviatore doccia componente esterno  
*Shower diverter external component*  
 Déviateur douche composant externe

3 outlets



Finitura/finish/finition €

CC-ON 100,00

NS-OP-OL-BO-NO-SE-TE 135,00

NP-TO-FE-TU-CM-CL-NM  
 AN-RU-CO-RO-PO-CE-CN 150,00

OO-OR 200,00

## ZC0DEV01GR

Componente incasso  
*Built-in part*  
 Composant intégré



GR 120,00

## ZC310304.E

Rubinetto arresto componente esterno  
*Stop cock external component*  
 Robinet d'arrêt composant externe



Finitura/finish/finition €

CC-ON 100,00

NS-OP-OL-BO-NO-SE-TE 135,00

NP-TO-FE-TU-CM-CL-NM  
 AN-RU-CO-RO-PO-CE-CN 150,00

OO-OR 200,00

## ZC0TRC02GR

Componente incasso  
*Built-in part*  
 Composant intégré



GR 50,00

## ZC310400

Rubinetto vasca  
Bath tap  
Mélangeur bain

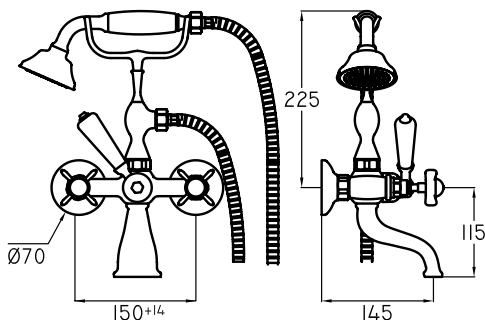

Finitura/finish/finition	€
CC-ON	920,00
NS-OP-OL-BO-NO-SE-TE	1.240,00
NP-TO-FE-TU-CM-CL-NM AN-RU-CO-RO-PO-CE-CN	1.380,00
OO-OR	1.840,00

## ZC310401.E

Rubinetto vasca componente esterno  
Bath tap external component  
Mélangeur bain composant externe

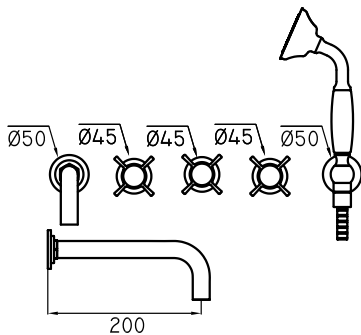

Finitura/finish/finition	€
CC-ON	700,00
NS-OP-OL-BO-NO-SE-TE	945,00
NP-TO-FE-TU-CM-CL-NM AN-RU-CO-RO-PO-CE-CN	1.050,00
OO-OR	1.400,00



### ZC0TRC04GR

Componente incasso  
Built-in part  
Composant intégré

	€
GR	200,00



### ZC0TRC04GR.C

Incasso per cartongesso  
Built-in part for drywall  
C. intégré pour cloison sèche

	€
GR	230,00



ZC32

## ZC320100

Miscelatore lavabo  
Basin mixer  
Mitigeur lavabo

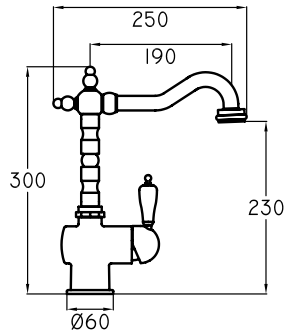

Finitura/finish/finition	€
CC-ON	310,00
NS-OP-OL-BO-NO-SE-TE	415,00
NP-TO-FE-TU-CM-CL-NM AN-RU-CO-RO-PO-CE-CN	465,00
OO-OR	620,00

## ZC320102

Miscelatore lavabo  
Basin mixer  
Mitigeur lavabo

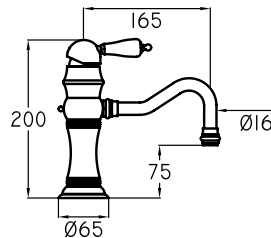

Finitura/finish/finition	€
CC-ON	310,00
NS-OP-OL-BO-NO-SE-TE	415,00
NP-TO-FE-TU-CM-CL-NM AN-RU-CO-RO-PO-CE-CN	465,00
OO-OR	620,00

## ZC320103

Miscelatore lavabo  
Basin mixer  
Mitigeur lavabo

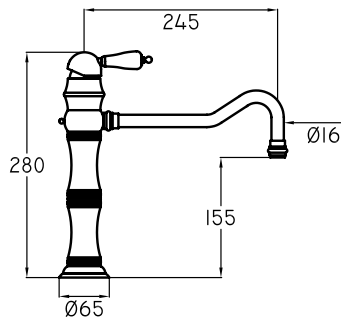

Finitura/finish/finition	€
CC-ON	390,00
NS-OP-OL-BO-NO-SE-TE	525,00
NP-TO-FE-TU-CM-CL-NM AN-RU-CO-RO-PO-CE-CN	585,00
OO-OR	780,00

## ZC320104

Rubinetto lavabo con scarico 1" 1/4  
Basin tap with 1" 1/4 pop-up waste  
Robinet lavabo avec vidage 1" 1/4

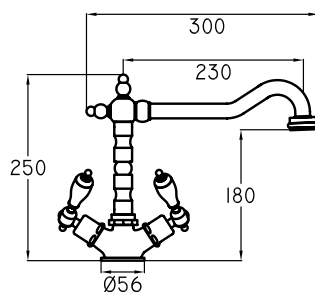

Finitura/finish/finition	€
CC-ON	280,00
NS-OP-OL-BO-NO-SE-TE	375,00
NP-TO-FE-TU-CM-CL-NM AN-RU-CO-RO-PO-CE-CN	420,00
OO-OR	560,00

## ZC320105

Rubinetto lavabo con scarico 1" 1/4  
*Basin tap with 1" 1/4 pop-up waste*  
 Robinet lavabo avec vidage 1" 1/4

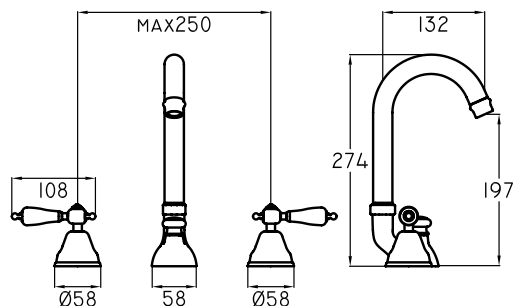

Finitura/finish/finition	€
CC-ON	330,00
NS-OP-OL-BO-NO-SE-TE	445,00
NP-TO-FE-TU-CM-CL-NM AN-RU-CO-RO-PO-CE-CN	495,00
OO-OR	660,00

## ZC320106.E

Miscelatore lavabo componente esterno  
*Basin mixer external component*  
 Mitigeur lavabo composant externe

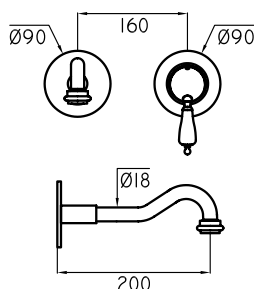

Finitura/finish/finition	€
CC-ON	290,00
NS-OP-OL-BO-NO-SE-TE	390,00
NP-TO-FE-TU-CM-CL-NM AN-RU-CO-RO-PO-CE-CN	435,00
OO-OR	580,00

### ZC0D3502GR

Componente incasso  
*Built-in part*  
 Composant intégré



GR 120,00

### ZC0D3502GR.C

Incasso per cartongesso  
*Built-in part for drywall*  
 C. intégré pour cloison sèche



GR 150,00

## ZC320107.E

Rubinetto lavabo componente esterno  
*Basin tap external component*  
 Mélangeur lavabo composant externe

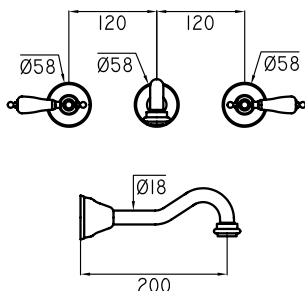

Finitura/finish/finition	€
CC-ON	300,00
NS-OP-OL-BO-NO-SE-TE	405,00
NP-TO-FE-TU-CM-CL-NM AN-RU-CO-RO-PO-CE-CN	450,00
OO-OR	600,00

### ZC0TRC05GR

Componente incasso  
*Built-in part*  
 Composant intégré



GR 140,00

### ZC0TRC05GR.C

Incasso per cartongesso  
*Built-in part for drywall*  
 C. intégré pour cloison sèche



GR 170,00

## ZC320108.E

Miscelatore lavabo componente esterno  
*Basin mixer external component*  
 Mitigeur lavabo composant externe

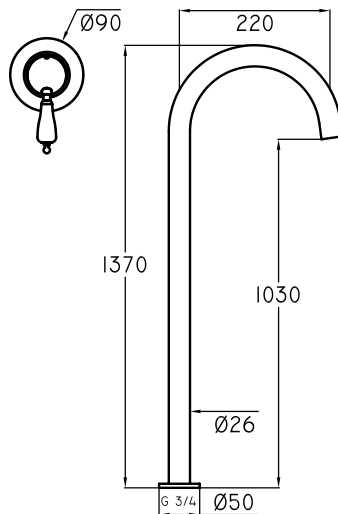
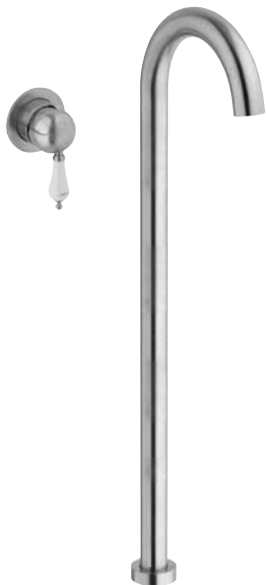

Finitura/finish/finition	€
CC-ON	600,00
NS-OP-OL-BO-NO-SE-TE	810,00
NP-TO-FE-TU-CM-CL-NM AN-RU-CO-RO-PO-CE-CN	900,00
OO-OR	1.200,00



### ZCOD3503GR

Componente incasso  
*Built-in part*  
 Composant intégré

	€
GR	90,00



### ZCOD3503GR.C

Incasso per cartongesso  
*Built-in part for drywall*  
 C. intégré pour cloison sèche

	€
GR	120,00

## ZC320201

Miscelatore bidet  
*Bidet mixer*  
 Mitigeur bidet

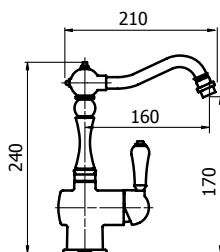

Finitura/finish/finition	€
CC-ON	280,00
NS-OP-OL-BO-NO-SE-TE	375,00
NP-TO-FE-TU-CM-CL-NM AN-RU-CO-RO-PO-CE-CN	420,00
OO-OR	560,00

## ZC320202

Rubinetto bidet con scarico 1" 1/4  
*Bidet tap with 1" 1/4 pop-up waste*  
 Robinet bidet avec vidage 1" 1/4

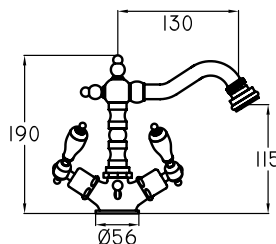

Finitura/finish/finition	€
CC-ON	280,00
NS-OP-OL-BO-NO-SE-TE	375,00
NP-TO-FE-TU-CM-CL-NM AN-RU-CO-RO-PO-CE-CN	420,00
OO-OR	560,00

## ZC320300.E

Miscelatore doccia componente esterno  
*Shower mixer external component*  
 Mitigeur douche composant externe

1 outlet

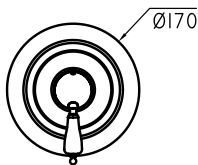

Finitura/finish/finition €

CC-ON 150,00

NS-OP-OL-BO-NO-SE-TE 200,00

NP-TO-FE-TU-CM-CL-NM  
 AN-RU-CO-RO-PO-CE-CN 225,00

OO-OR 300,00



### ZCOD3503GR

Componente incasso  
*Built-in part*  
 Composant intégré

€

GR 90,00



### ZCOD3503GR.C

Incasso per cartongesso  
*Built-in part for drywall*  
 C. intégré pour cloison sèche

€

GR 120,00

## ZC320301.E

Miscelatore doccia componente esterno  
*Shower mixer external component*  
 Mitigeur douche composant externe

2 outlets

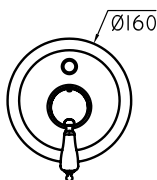

Finitura/finish/finition €

CC-ON 220,00

NS-OP-OL-BO-NO-SE-TE 295,00

NP-TO-FE-TU-CM-CL-NM  
 AN-RU-CO-RO-PO-CE-CN 330,00

OO-OR 440,00



### ZCOD3504GR

Componente incasso  
*Built-in part*  
 Composant intégré

€

GR 135,00



### ZCOD3504GR.C

Incasso per cartongesso  
*Built-in part for drywall*  
 C. intégré pour cloison sèche

€

GR 165,00

## ZC320303.E

Miscelatore doccia componente esterno  
*Shower mixer external component*  
 Mitigeur douche composant externe

2 outlets

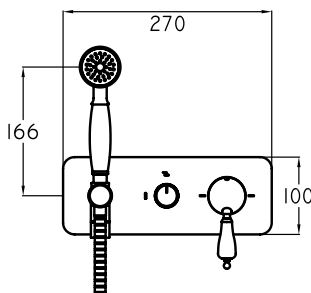

Finitura/finish/finition €

CC-ON 510,00

NS-OP-OL-BO-NO-SE-TE 685,00

NP-TO-FE-TU-CM-CL-NM  
 AN-RU-CO-RO-PO-CE-CN 765,00

OO-OR 1.020,00



### ZCOD3509GR

Componente incasso  
*Built-in part*  
 Composant intégré

€

GR 200,00



### ZCOD3509GR.C

Incasso per cartongesso  
*Built-in part for drywall*  
 C. intégré pour cloison sèche

€

GR 230,00



## ZC320304.E

Rubinetto doccia componente esterno  
*Shower tap external component*  
 Mélangeur douche composant externe

1 outlet

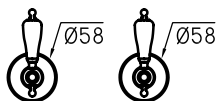

Finitura/finish/finition	€
CC-ON	340,00
NS-OP-OL-BO-NO-SE-TE	460,00
NP-TO-FE-TU-CM-CL-NM AN-RU-CO-RO-PO-CE-CN	510,00
OO-OR	680,00



## ZC0TR07GR

Componente incasso  
*Built-in part*  
 Composant intégré

GR € 100,00

## ZC320305.E

Rubinetto doccia componente esterno  
*Shower tap external component*  
 Mélangeur douche composant externe

1 outlet

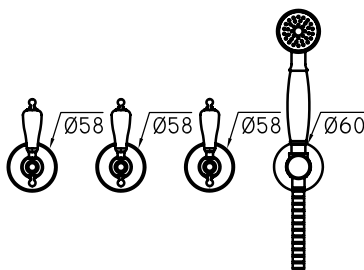
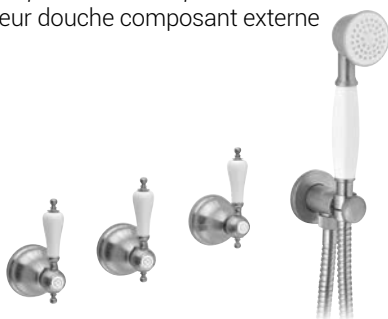

Finitura/finish/finition	€
CC-ON	600,00
NS-OP-OL-BO-NO-SE-TE	810,00
NP-TO-FE-TU-CM-CL-NM AN-RU-CO-RO-PO-CE-CN	900,00
OO-OR	1.200,00



## ZC0TR08GR

Componente incasso  
*Built-in part*  
 Composant intégré

GR € 200,00



## ZC0TR08GR.C

Incasso per cartongesso  
*Built-in part for drywall*  
 C. intégré pour cloison sèche

GR € 230,00

## ZC320306.E

Deviatore componente esterno  
*Diverter external component*  
 Dèviateur composant externe

3 outlets



Finitura/finish/finition	€
CC-ON	170,00
NS-OP-OL-BO-NO-SE-TE	230,00
NP-TO-FE-TU-CM-CL-NM AN-RU-CO-RO-PO-CE-CN	260,00
OO-OR	340,00



## ZC0DEV01GR

Componente incasso  
*Built-in part*  
 Composant intégré

GR € 120,00

## ZC320307.E

Rubinetto d'arresto componente esterno  
*Stop cock external component*  
 Robinet d'arret composant externe

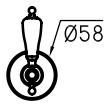

Finitura/finish/finition	€
CC-ON	170,00
NS-OP-OL-BO-NO-SE-TE	230,00
NP-TO-FE-TU-CM-CL-NM AN-RU-CO-RO-PO-CE-CN	260,00
OO-OR	340,00

## ZC0TR06GR.C

Componente incasso  
*Built-in part*  
 Composant intégré



	€
GR	50,00

## ZC320401

Rubinetto vasca  
*Bath tap*  
 Mélangeur bain

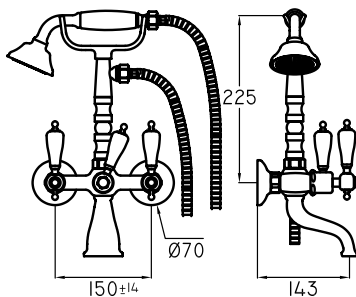

Finitura/finish/finition	€
CC-ON	510,00
NS-OP-OL-BO-NO-SE-TE	690,00
NP-TO-FE-TU-CM-CL-NM AN-RU-CO-RO-PO-CE-CN	765,00
OO-OR	1.020,00

GR

## ZC320402.E

Miscelatore vasca componente esterno  
*Bath mixer external component*  
 Mitigeur bain composant externe

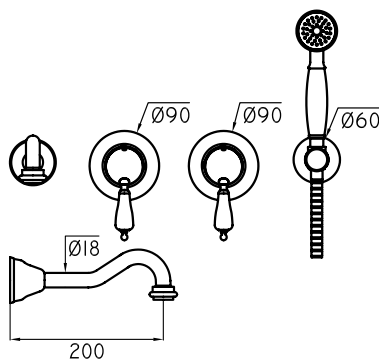

Finitura/finish/finition	€
CC-ON	975,00
NS-OP-OL-BO-NO-SE-TE	1.320,00
NP-TO-FE-TU-CM-CL-NM AN-RU-CO-RO-PO-CE-CN	1.460,00
OO-OR	1.950,00



## ZC0D3508GR

Componente incasso  
*Built-in part*  
 Composant intégré

	€
GR	180,00



## ZC0D3508GR.C

Incasso per cartongesso  
*Built-in part for drywall*  
 C. intégré pour cloison sèche

	€
GR	240,00

# ZC320403.E

Rubinetto vasca componente esterno  
*Bath tap external component*  
 Mélangeur bain composant externe



1 outlet

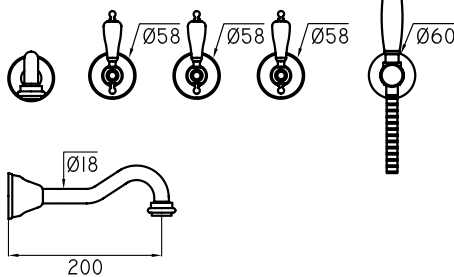

Finitura/finish/finition	€
CC-ON	1.135,00
NS-OP-OL-BO-NO-SE-TE	1.800,00
NP-TO-FE-TU-CM-CL-NM AN-RU-CO-RO-PO-CE-CN	2.000,00
OO-OR	2.670,00



## ZC0TR08GR

Componente incasso  
*Built-in part*  
 Composant intégré

GR	€
GR	200,00



## ZC0TR08GR.C

Incasso per cartongesso  
*Built-in part for drywall*  
 C. intégré pour cloison sèche

GR	€
GR	230,00

ACCESSORI  
*ACCESSORIES*  
ACCESSOIRES

## ZC000800

Soffione ø 300 mm  
Shower head ø mm 300  
Pommeau de douche ø mm 300

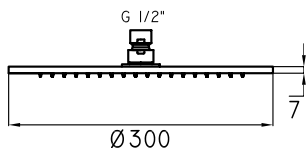

Finitura/finish/finition	€
CC-ON	330,00
NS-OP-OL-BO-NO-SE-TE	445,00
NP-TO-FE-TU-CM-CL-NM AN-RU-CO-RO-PO-CE-CN	495,00
OO-OR	660,00

## ZC000801

Soffione ø 200 mm  
Shower head ø mm 200  
Pommeau de douche ø mm 200

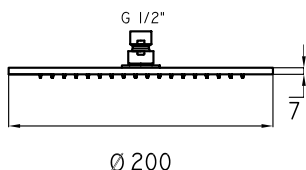

Finitura/finish/finition	€
CC-ON	275,00
NS-OP-OL-BO-NO-SE-TE	375,00
NP-TO-FE-TU-CM-CL-NM AN-RU-CO-RO-PO-CE-CN	415,00
OO-OR	550,00

## ZC000802

Soffione 300x300 mm  
Shower head mm 300x300  
Pommeau de douche mm 300x300

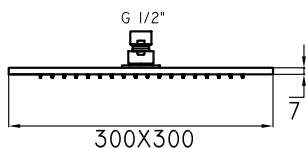

Finitura/finish/finition	€
CC-ON	375,00
NS-OP-OL-BO-NO-SE-TE	510,00
NP-TO-FE-TU-CM-CL-NM AN-RU-CO-RO-PO-CE-CN	565,00
OO-OR	750,00

## ZC000803

Soffione 200x200 mm  
Shower head mm 200x200  
Pommeau de douche mm 200x200

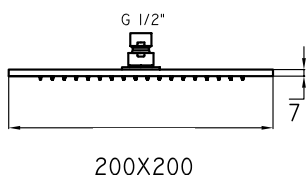

Finitura/finish/finition	€
CC-ON	330,00
NS-OP-OL-BO-NO-SE-TE	445,00
NP-TO-FE-TU-CM-CL-NM AN-RU-CO-RO-PO-CE-CN	495,00
OO-OR	660,00

## ZC000804

Soffione cascata  
Cascade shower head  
Pommeau de douche cascade

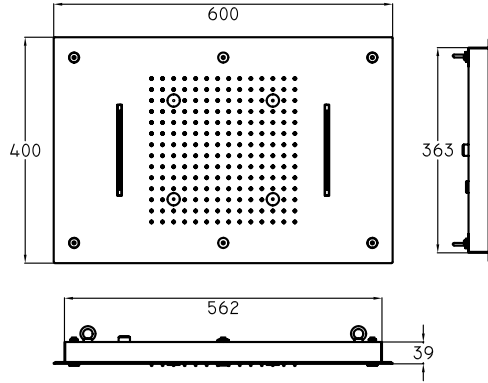
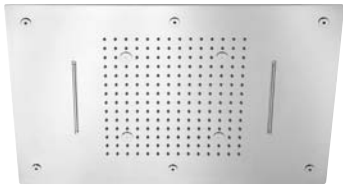

Finitura/finish/finition €

CC 1.585,00

## ZC000805

Soffione cascata  
Cascade shower head  
Pommeau de douche cascade

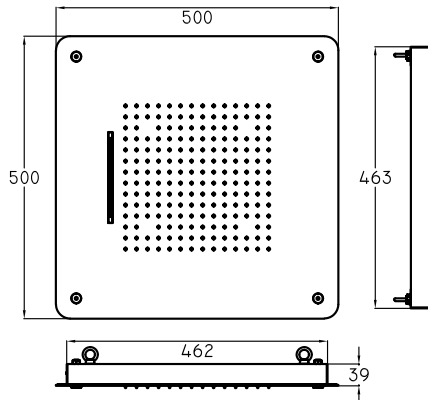
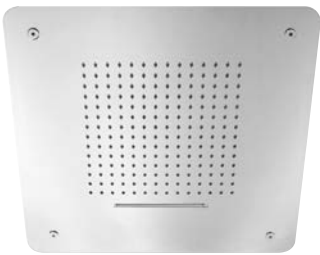

Finitura/finish/finition €

CC 1.065,00

## ZC000806

Soffione cascata  
Cascade shower head  
Pommeau de douche cascade

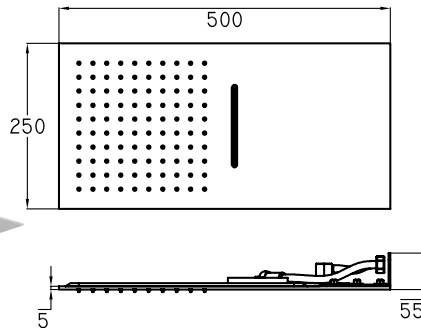

Finitura/finish/finition €

CC 685,00

## ZC000807

Soffione cromoterapia  $\varnothing$  300 mm  
Chromotherapy shower head  $\varnothing$  mm 300  
Pommeau de douche chromotherapie  $\varnothing$  mm 300

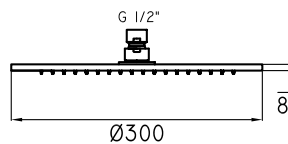

Finitura/finish/finition €

CC 875,00

## ZC000808

Soffione cromoterapia 300x300 mm  
 Chromotherapy shower head mm 300x300  
 Pommeau de douche chromotherapie mm 300x300

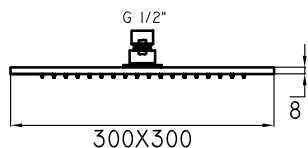

Finitura/finish/finition	€
CC	975,00

## ZC000809

Braccio doccia  
 Shower arm  
 Bras de douche

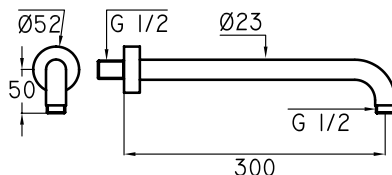

Finitura/finish/finition	€
CC-ON	95,00
NS-OP-OL-BO-NO-SE-TE	125,00
NP-TO-FE-TU-CM-CL-NM AN-RU-CO-RO-PO-CE-CN	145,00
OO-OR	190,00

## ZC000810

Braccio doccia  
 Shower arm  
 Bras de douche

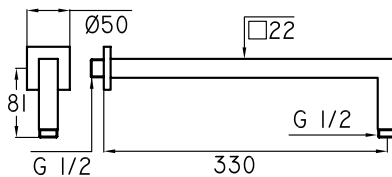

Finitura/finish/finition	€
CC-ON	110,00
NS-OP-OL-BO-NO-SE-TE	150,00
NP-TO-FE-TU-CM-CL-NM AN-RU-CO-RO-PO-CE-CN	165,00
OO-OR	220,00

## ZC000811

Braccio doccia  
 Shower arm  
 Bras de douche

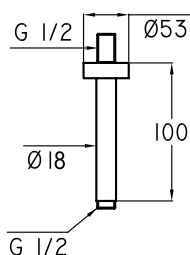

Finitura/finish/finition	€
CC-ON	95,00
NS-OP-OL-BO-NO-SE-TE	125,00
NP-TO-FE-TU-CM-CL-NM AN-RU-CO-RO-PO-CE-CN	145,00
OO-OR	190,00

## ZC000812

Braccio doccia  
Shower arm  
Bras de douche

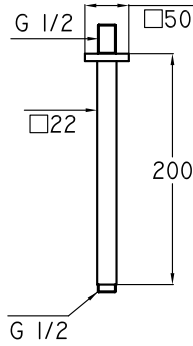

Finitura/finish/finition	€
CC-ON	110,00
NS-OP-OL-BO-NO-SE-TE	150,00
NP-TO-FE-TU-CM-CL-NM AN-RU-CO-RO-PO-CE-CN	165,00
OO-OR	220,00

## ZC000813

Soffione laterale  
Body jet  
Pommeau de douche pour le corp

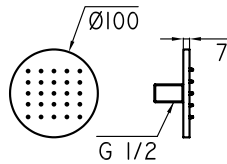

Finitura/finish/finition	€
CC-ON	85,00
NS-OP-OL-BO-NO-SE-TE	115,00
NP-TO-FE-TU-CM-CL-NM AN-RU-CO-RO-PO-CE-CN	130,00
OO-OR	170,00

## ZC000814

Soffione laterale  
Body jet  
Pommeau de douche pour le corp

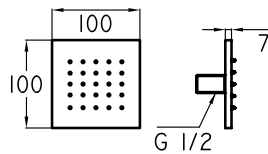

Finitura/finish/finition	€
CC-ON	95,00
NS-OP-OL-BO-NO-SE-TE	125,00
NP-TO-FE-TU-CM-CL-NM AN-RU-CO-RO-PO-CE-CN	145,00
OO-OR	190,00



# ZC000817

Colonna doccia  
Shower column  
Colonne de douche

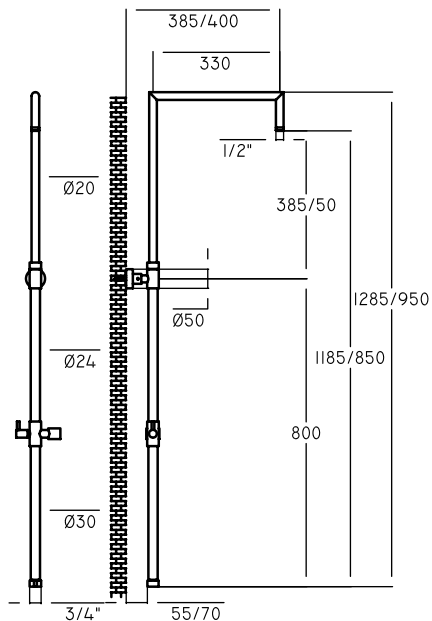

Finitura/finish/finition	€
CC-ON	800,00
NS-OP-OL-BO-NO-SE-TE	1.080,00
NP-TO-FE-TU-CM-CL-NM AN-RU-CO-RO-PO-CE-CN	1.200,00
OO-OR	1.600,00

# ZC000819

Saliscendi  
Sliding rail  
Barre de douche

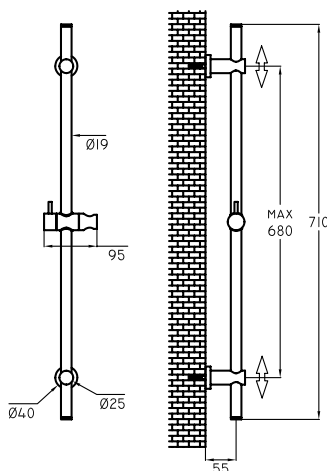

Finitura/finish/finition	€
CC-ON	220,00
NS-OP-OL-BO-NO-SE-TE	300,00
NP-TO-FE-TU-CM-CL-NM AN-RU-CO-RO-PO-CE-CN	330,00
OO-OR	440,00

# ZC000818

Colonna doccia  
Shower column  
Colonne de douche

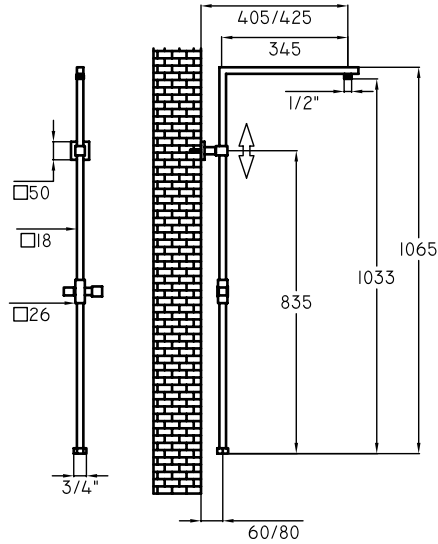

Finitura/finish/finition	€
CC	950,00
NS-BO-NO-SE-TE	1.285,00
NP-TU-CL-NM AN-RU-CO-RO-PO-CE-CN	1.425,00
OO-OR	1.900,00

# ZC000820

Saliscendi  
Sliding rail  
Barre de douche

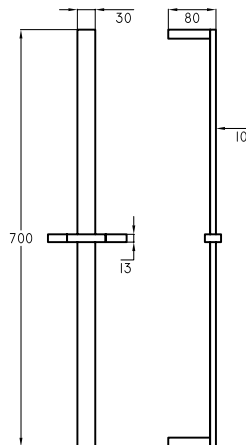

Finitura/finish/finition	€
CC	250,00
NS-BO-NO-SE-TE	340,00
NP-TU-CL-NM AN-RU-CO-RO-PO-CE-CN	375,00
OO-OR	500,00

## ZC000821

Saliscendi  
Sliding rail  
Barre de douche

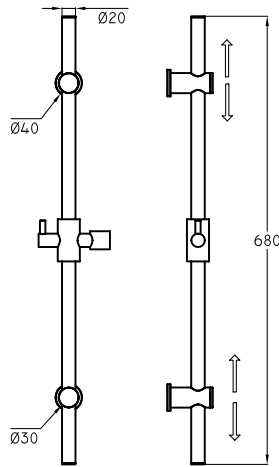

Finitura/finish/finition	€
CC	190,00
NS-BO-NO	255,00

## ZC000822

Kit doccia  
Shower kit  
Kit de douche

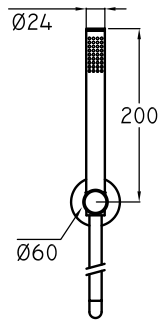

Finitura/finish/finition	€
CC-ON	140,00
NS-OP-OL-BO-NO-SE-TE	190,00
NP-TO-FE-TU-CM-CL-NM AN-RU-CO-RO-PO-CE-CN	210,00
OO-OR	280,00

## ZC000823

Kit doccia  
Shower kit  
Kit de douche

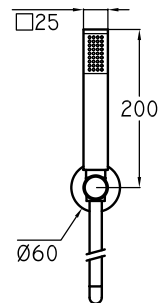

Finitura/finish/finition	€
CC	170,00
NS-BO-NO-SE-TE	230,00
NP-TU-CL-NM AN-RU-CO-RO-PO-CE-CN	255,00
OO-OR	340,00

## ZC000829

Kit doccia  
Shower kit  
Kit de douche

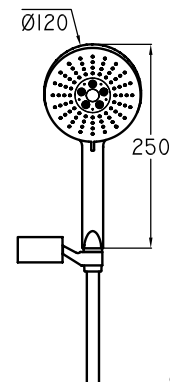

Finitura/finish/finition	€
CC	130,00
NS-BO-NO	175,00

## ZC000824

Soffione ø 200 mm  
Shower head ø mm 200  
Pommeau de douche ø mm 200

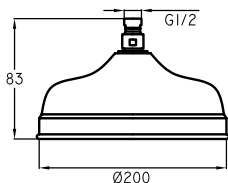

Finitura/finish/finition	€
CC-ON	250,00
NS-OP-OL-BO-NO-SE-TE	340,00
NP-TO-FE-TU-CM-CL-NM AN-RU-CO-RO-PO-CE-CN	375,00
OO-OR	500,00

## ZC000825

Braccio doccia  
Shower arm  
Bras de douche

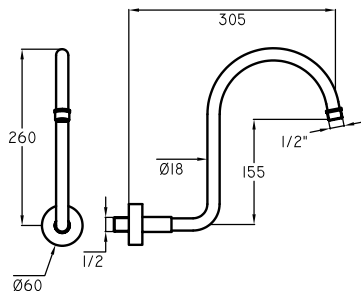

Finitura/finish/finition	€
CC-ON	120,00
NS-OP-OL-BO-NO-SE-TE	165,00
NP-TO-FE-TU-CM-CL-NM AN-RU-CO-RO-PO-CE-CN	180,00
OO-OR	240,00

## ZC000826

Colonna doccia  
Shower column  
Colonne de douche

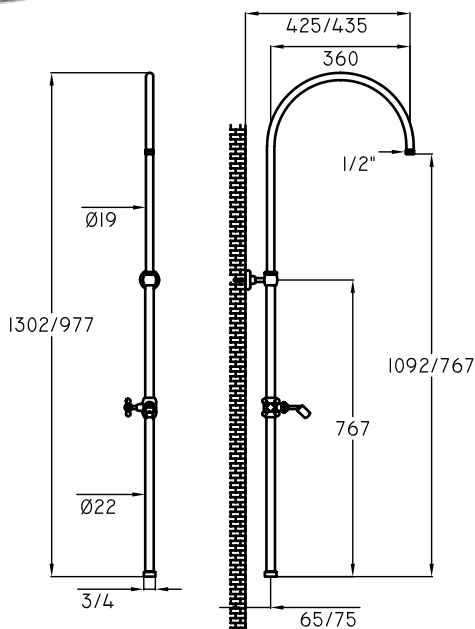

Finitura/finish/finition	€
CC-ON	890,00
NS-OP-OL-BO-NO-SE-TE	1.200,00
NP-TO-FE-TU-CM-CL-NM AN-RU-CO-RO-PO-CE-CN	1.335,00
OO-OR	1.780,00

# ZC000827

Saliscendi  
Sliding rail  
Barre de douche

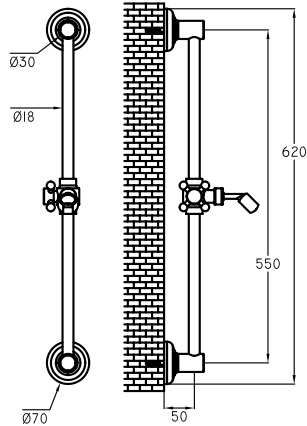

Finitura/finish/finition	€
CC-ON	170,00
NS-OP-OL-BO-NO-SE-TE	230,00
NP-TO-FE-TU-CM-CL-NM AN-RU-CO-RO-PO-CE-CN	255,00
OO-OR	340,00

# ZC000828

Kit doccia  
Shower kit  
Kit de douche

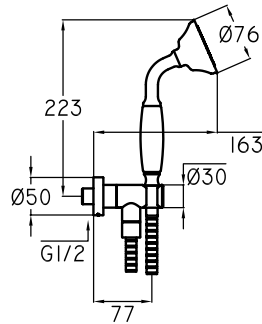

Finitura/finish/finition	€
CC-ON	160,00
NS-OP-OL-BO-NO-SE-TE	215,00
NP-TO-FE-TU-CM-CL-NM AN-RU-CO-RO-PO-CE-CN	240,00
OO-OR	320,00

COMPONENTI IDRAULICI  
*HYDRAULIC COMPONENTS*  
*COMPOSANTS HYDRAULIQUES*

## ZC000701

Scarico pop up con troppo pieno  
*Pop up waste with overflow*  
Vidange pop-up avec trop plein

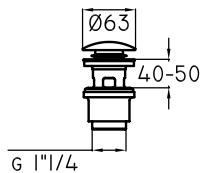

Finitura/finish/finition	€
CC-ON	65,00
NS-OP-OL-BO-NO-SE-TE	90,00
NP-TO-FE-TU-CM-CL-NM AN-RU-CO-RO-PO-CE-CN	100,00
OO-OR	130,00

## ZC000702

Scarico pop up senza troppo pieno  
*Pop up waste with overflow*  
Vidange pop-up sans trop plein

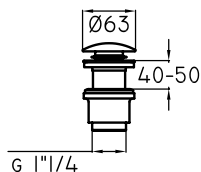

Finitura/finish/finition	€
CC-ON	65,00
NS-OP-OL-BO-NO-SE-TE	90,00
NP-TO-FE-TU-CM-CL-NM AN-RU-CO-RO-PO-CE-CN	100,00
OO-OR	130,00

## ZC000727

Scarico pop up senza troppo pieno  
*Pop up waste with overflow*  
Vidange pop-up sans trop plein

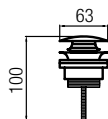

Finitura/finish/finition	€
CC-ON	90,00
NS-OP-OL-BO-NO-SE-TE	120,00
NP-TO-FE-TU-CM-CL-NM AN-RU-CO-RO-PO-CE-CN	140,00
OO-OR	180,00

## ZC000729

Scarico pop up senza troppo pieno  
*Pop up waste with overflow*  
Vidange pop-up sans trop plein

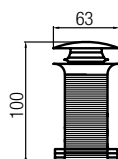

Finitura/finish/finition	€
CC-ON	90,00
NS-OP-OL-BO-NO-SE-TE	120,00
NP-TO-FE-TU-CM-CL-NM AN-RU-CO-RO-PO-CE-CN	140,00
OO-OR	180,00

## ZC000703

Rubinetto filtro  
Filter tap  
Robinet filtre

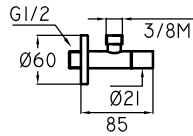

Finitura/finish/finition	€
CC-ON	65,00
NS-OP-OL-BO-NO-SE-TE	85,00
NP-TO-FE-TU-CM-CL-NM AN-RU-CO-RO-PO-CE-CN	95,00
OO-OR	130,00

## ZC000704

Rubinetto filtro  
Filter tap  
Robinet filtre

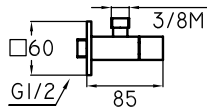

Finitura/finish/finition	€
CC-ON	75,00
NS-OP-OL-BO-NO-SE-TE	100,00
NP-TO-FE-TU-CM-CL-NM AN-RU-CO-RO-PO-CE-CN	115,00
OO-OR	150,00

## ZC000705

Sifone  
Syphon  
Siphon

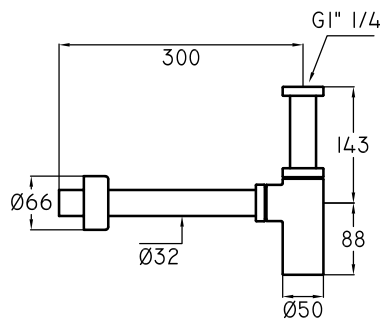

Finitura/finish/finition	€
CC-ON	120,00
NS-OP-OL-BO-NO-SE-TE	165,00
NP-TO-FE-TU-CM-CL-NM AN-RU-CO-RO-PO-CE-CN	180,00
OO-OR	240,00

## ZC000706

Sifone  
Syphon  
Siphon

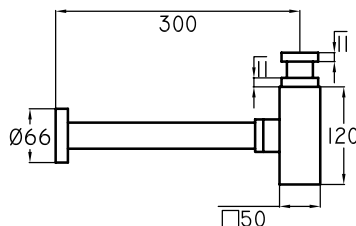

Finitura/finish/finition	€
CC-ON	140,00
NS-OP-OL-BO-NO-SE-TE	190,00
NP-TO-FE-TU-CM-CL-NM AN-RU-CO-RO-PO-CE-CN	210,00
OO-OR	280,00



## ZC000707

Presacqua  
Water connection  
Prise d'eau

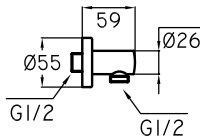

Finitura/finish/finition	€
CC-ON	50,00
NS-OP-OL-BO-NO-SE-TE	65,00
NP-TO-FE-TU-CM-CL-NM AN-RU-CO-RO-PO-CE-CN	75,00
OO-OR	100,00

## ZC000708

Presacqua  
Water connection  
Prise d'eau

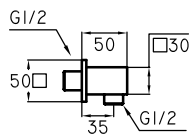

Finitura/finish/finition	€
CC-ON	60,00
NS-OP-OL-BO-NO-SE-TE	75,00
NP-TO-FE-TU-CM-CL-NM AN-RU-CO-RO-PO-CE-CN	85,00
OO-OR	120,00

## ZC000709

Idroscopino 1 acqua  
Shut off mixer 1 water  
Kit pour wc complet 1 eau

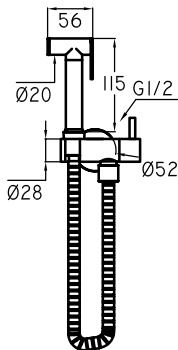

Finitura/finish/finition	€
CC-ON	170,00
NS-OP-OL-BO-NO-SE-TE	230,00
NP-TO-FE-TU-CM-CL-NM AN-RU-CO-RO-PO-CE-CN	255,00
OO-OR	340,00

Articolo venduto solo a completamento di una serie bagno.  
Item only sold to complete a bathroom collection.  
Article vendu pour compléter une série salle de bain.

## ZC000710

Idroscopino 1 acqua  
Shut off mixer 1 water  
Kit pour wc complet 1 eau

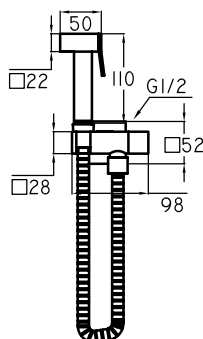

Finitura/finish/finition	€
CC-ON	210,00
NS-OP-OL-BO-NO-SE-TE	285,00
NP-TO-FE-TU-CM-CL-NM AN-RU-CO-RO-PO-CE-CN	315,00
OO-OR	420,00

Articolo venduto solo a completamento di una serie bagno.  
Item only sold to complete a bathroom collection.  
Article vendu pour compléter une série salle de bain.

## ZC000711

Bocca  
Spout  
Bec

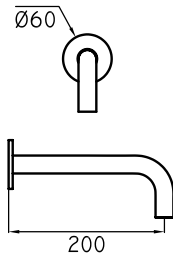

Finitura/finish/finition	€
CC-ON	110,00
NS-OP-OL-BO-NO-SE-TE	148,00
NP-TO-FE-TU-CM-CL-NM AN-RU-CO-RO-PO-CE-CN	165,00
OO-OR	220,00

## ZC000712

Bocca  
Spout  
Bec

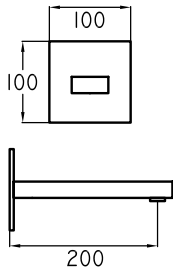

Finitura/finish/finition	€
CC-ON	150,00
NS-OP-OL-BO-NO-SE-TE	205,00
NP-TO-FE-TU-CM-CL-NM AN-RU-CO-RO-PO-CE-CN	225,00
OO-OR	300,00

## ZC000714

Cascata  
Cascade  
Cascade

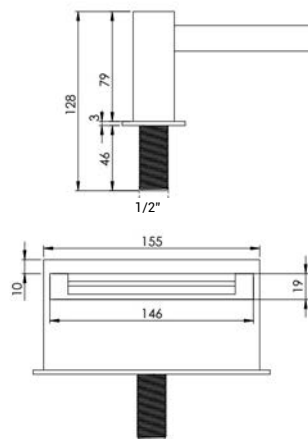

Finitura/finish/finition	€
CC-ON	1.100,00
NS-OP-OL-BO-NO-SE-TE	1.485,00
NP-TO-FE-TU-CM-CL-NM AN-RU-CO-RO-PO-CE-CN	1.650,00
OO-OR	2.200,00

## ZC000715

Cascata  
Cascade  
Cascade

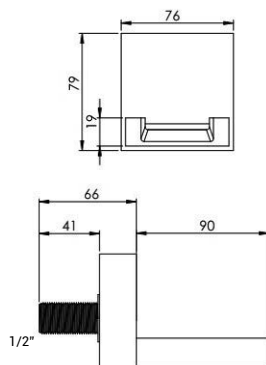

Finitura/finish/finition	€
CC-ON	700,00
NS-OP-OL-BO-NO-SE-TE	945,00
NP-TO-FE-TU-CM-CL-NM AN-RU-CO-RO-PO-CE-CN	1.175,00
OO-OR	1.400,00

## ZC000815

Cascata  
Cascade  
Cascade

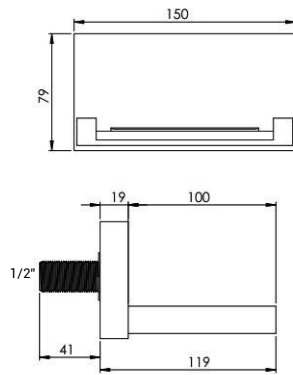

Finitura/finish/finition	€
CC-ON	1.100,00
NS-OP-OL-BO-NO-SE-TE	1.485,00
NP-TO-FE-TU-CM-CL-NM AN-RU-CO-RO-PO-CE-CN	1.650,00
OO-OR	2.200,00

## ZC000700

Bocca a pavimento  
Free standing spout  
Bec pour plancher

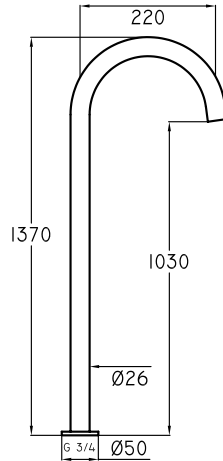

Finitura/finish/finition	€
CC-ON	370,00
NS-OP-OL-BO-NO-SE-TE	500,00
NP-TO-FE-TU-CM-CL-NM AN-RU-CO-RO-PO-CE-CN	555,00
OO-OR	740,00

## ZC000717

Piastra wc  
Wc plate  
Plaque wc

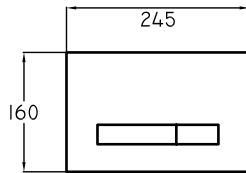

Finitura/finish/finition	€
CC-ON	450,00
NS-OP-OL-BO-NO-SE-TE	580,00
NP-TO-FE-TU-CM-CL-NM AN-RU-CO-RO-PO-CE-CN	675,00
OO-OR	900,00

## ZC000718

Rubinetto filtro  
Filter tap  
Robinet filtre

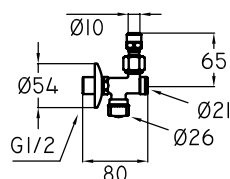

Finitura/finish/finition	€
CC-ON	55,00
NS-OP-OL-BO-NO-SE-TE	75,00
NP-TO-FE-TU-CM-CL-NM AN-RU-CO-RO-PO-CE-CN	95,00
OO-OR	110,00

## ZC000719

Sifone  
Syphon  
Siphon

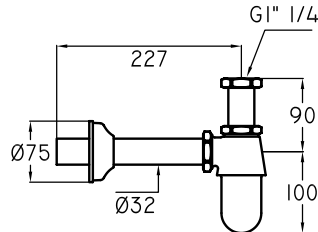

Finitura/finish/finition	€
CC-ON	120,00
NS-OP-OL-BO-NO-SE-TE	165,00
NP-TO-FE-TU-CM-CL-NM AN-RU-CO-RO-PO-CE-CN	180,00
OO-OR	240,00

## ZC000720

Sifone  
Syphon  
Siphon

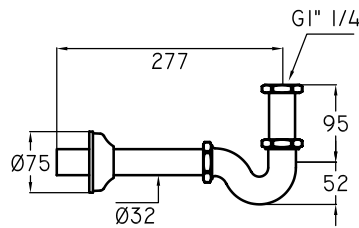

Finitura/finish/finition	€
CC-ON	120,00
NS-OP-OL-BO-NO-SE-TE	165,00
NP-TO-FE-TU-CM-CL-NM AN-RU-CO-RO-PO-CE-CN	180,00
OO-OR	240,00

## ZC000721

Preso acqua  
Water connection  
Prise d'eau

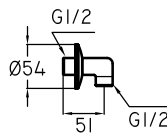

Finitura/finish/finition	€
CC-ON	40,00
NS-OP-OL-BO-NO-SE-TE	55,00
NP-TO-FE-TU-CM-CL-NM AN-RU-CO-RO-PO-CE-CN	60,00
OO-OR	80,00

## ZC000722

Idroscopino 1 acqua  
Shut off mixer 1 water  
Kit pour wc complet 1 eau

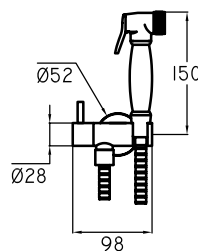

Finitura/finish/finition	€
CC	180,00

Articolo venduto solo a completamento di una serie bagno.  
*Item only sold to complete a bathroom collection.*  
Article vendu pour compléter une série salle de bain.

## ZC000723

Tubi a pavimento  
Free standing pipes  
Tubes de sol

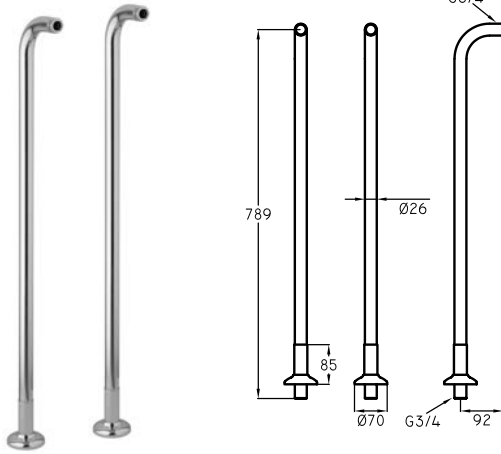

Finitura/finish/finition	€
CC-ON	355,00
NS-OP-OL-BO-NO-SE-TE	500,00
NP-TO-FE-TU-CM-CL-NM AN-RU-CO-RO-PO-CE-CN	535,00
OO-OR	710,00

## ZC000716

Tubi a pavimento  
Free standing pipes  
Tubes de sol

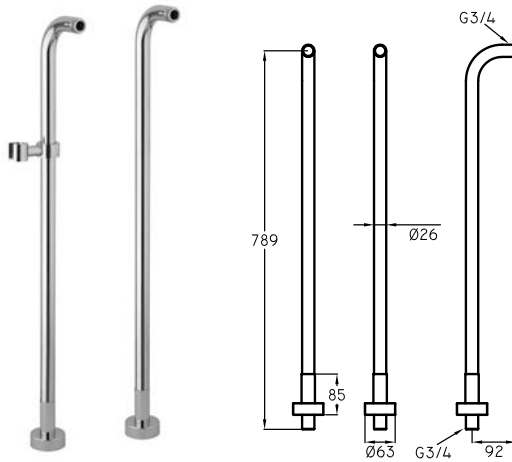

Finitura/finish/finition	€
CC-ON	420,00
NS-OP-OL-BO-NO-SE-TE	565,00
NP-TO-FE-TU-CM-CL-NM AN-RU-CO-RO-PO-CE-CN	630,00
OO-OR	840,00

ACCESSORI BAGNO\_ZC63  
*BATH ACCESSORIES\_ZC63*  
ACCESSOIRES DE BAIN\_ZC63

## ZC630100

Portasalvietta l. 327 mm  
Towel holder mm 327 l.  
Porte-serviette mm 327

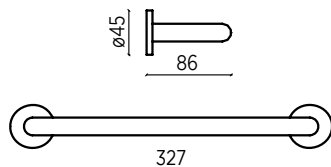

Finitura/finish/finition	€
CC-ON	150,00
NS-OP-OL-BO-NO-SE-TE	190,00
NP-TO-FE-TU-CM-CL-NM AN-RU-CO-RO-PO-CE-CN	225,00
OO-OR	300,00

## ZC630101

Portasalvietta l. 427 mm  
Towel holder mm 427 l.  
Porte-serviette mm 427

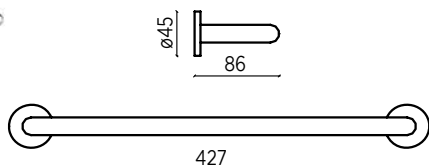

Finitura/finish/finition	€
CC-ON	170,00
NS-OP-OL-BO-NO-SE-TE	210,00
NP-TO-FE-TU-CM-CL-NM AN-RU-CO-RO-PO-CE-CN	245,00
OO-OR	320,00

## ZC630102

Portasalvietta l. 627 mm  
Towel holder mm 627 l.  
Porte-serviette mm 627

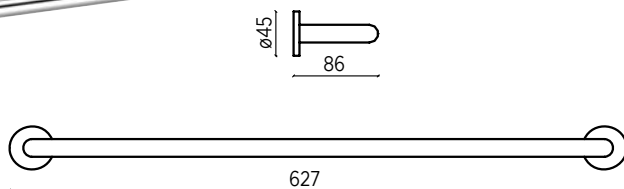

Finitura/finish/finition	€
CC-ON	190,00
NS-OP-OL-BO-NO-SE-TE	230,00
NP-TO-FE-TU-CM-CL-NM AN-RU-CO-RO-PO-CE-CN	265,00
OO-OR	340,00

## ZC630103

Portarotolo  
Toilet paper holder  
Porte papier hygiénique



Finitura/finish/finition	€
CC-ON	100,00
NS-OP-OL-BO-NO-SE-TE	125,00
NP-TO-FE-TU-CM-CL-NM AN-RU-CO-RO-PO-CE-CN	150,00
OO-OR	200,00

## ZC630104

Appendino  
Hook  
Crochet

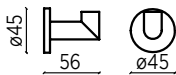

Finitura/finish/finition	€
CC-ON	100,00
NS-OP-OL-BO-NO-SE-TE	125,00
NP-TO-FE-TU-CM-CL-NM AN-RU-CO-RO-PO-CE-CN	150,00
OO-OR	200,00

## ZC630105

Appendino  
Hook  
Crochet

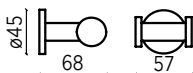

Finitura/finish/finition	€
CC-ON	120,00
NS-OP-OL-BO-NO-SE-TE	155,00
NP-TO-FE-TU-CM-CL-NM AN-RU-CO-RO-PO-CE-CN	180,00
OO-OR	240,00

## ZC630106

Portarotolo  
Toilet paper holder  
Porte papier hygiénique

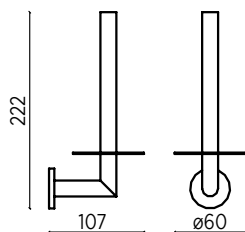

Finitura/finish/finition	€
CC-ON	100,00
NS-OP-OL-BO-NO-SE-TE	125,00
NP-TO-FE-TU-CM-CL-NM AN-RU-CO-RO-PO-CE-CN	150,00
OO-OR	200,00

## ZC630107

Portasalviette  
Towel holder  
Porte-serviette

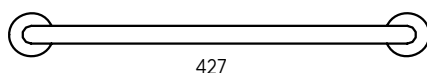
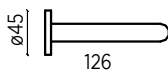

Finitura/finish/finition	€
CC-ON	230,00
NS-OP-OL-BO-NO-SE-TE	300,00
NP-TO-FE-TU-CM-CL-NM AN-RU-CO-RO-PO-CE-CN	345,00
OO-OR	460,00



## ZC630108

Portasalvietta  
Towel holder  
Porte-serviette

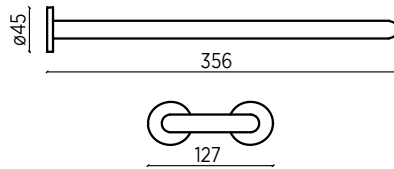

Finitura/finish/finition	€
CC-ON	230,00
NS-OP-OL-BO-NO-SE-TE	300,00
NP-TO-FE-TU-CM-CL-NM AN-RU-CO-RO-PO-CE-CN	345,00
OO-OR	460,00

## ZC630109

Portascopino  
Toilet brush  
Porte-brosse WC

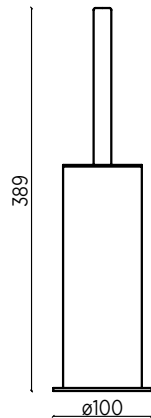

Finitura/finish/finition	€
CC	220,00
NS-BO-NO-SE-TE	295,00
NP-TU-CM-NM AN-RU-CO-RO-PO-CE-CN	330,00
OO-OR	440,00

## ZC630110

Porta spazzolino  
Toothbrush holder  
Porte-brosse WC

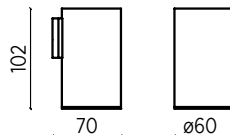

Finitura/finish/finition	€
CC	170,00
NS-BO-NO-SE-TE	210,00
NP-TU-CM-NM AN-RU-CO-RO-PO-CE-CN	245,00
OO-OR	320,00

## ZC630111

Porta sapone  
Soap dish  
Porte-savon

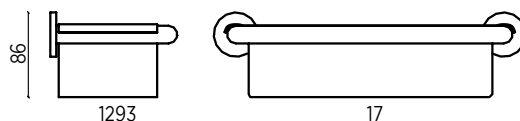

Finitura/finish/finition	€
CC	220,00
NS-BO-NO-SE-TE	295,00
NP-TU-CM-NM AN-RU-CO-RO-PO-CE-CN	330,00
OO-OR	440,00

## ZC630112

Dispenser sapone  
*Soap dispenser*  
Distributeur de savon

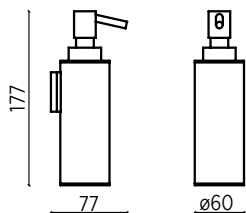

Finitura/finish/finition	€
CC	220,00
NS-BO-NO-SE-TE	295,00
NP-TU-CM-NM AN-RU-CO-PO-CE-CN	330,00
OO-OR	440,00

## ZC630113

Porta sapone  
*Soap dish*  
Porte-savon

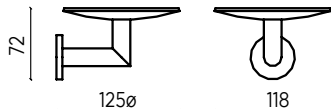

Finitura/finish/finition	€
CC	220,00
NS-BO-NO-SE-TE	295,00
NP-TU-CM-NM AN-RU-CO-PO-CE-CN	330,00
OO-OR	440,00

## ZC630114

Mensola  
*Shelf*  
Étagère

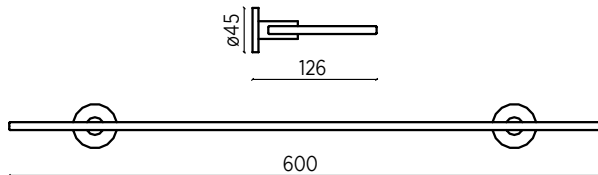

Finitura/finish/finition	€
CC-ON	230,00
NS-OP-OL-BO-NO-SE-TE	300,00
NP-TO-FE-TU-CM-CL-NM AN-RU-CO-PO-CE-CN	345,00
OO-OR	460,00



ACCESSORI BAGNO\_ZC64  
*BATH ACCESSORIES\_ZC64*  
ACCESSOIRES DE BAIN\_ZC64

## ZC640100

Portasalviette l. 340 mm  
Towel holder mm 340 l.  
Porte-serviette mm 340

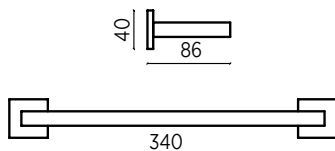

Finitura/finish/finition	€
CC-ON	200,00
NS-OP-OL-BO-NO-SE-TE	250,00
NP-TO-FE-TU-CM-CL-NM AN-RU-CO-RO-PO-CE-CN	300,00
OO-OR	400,00

## ZC640101

Portasalviette l. 490 mm  
Towel holder mm 490 l.  
Porte-serviette mm 490

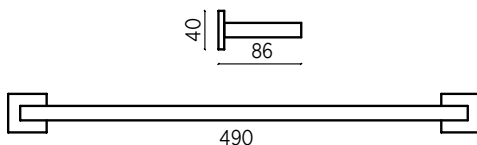

Finitura/finish/finition	€
CC-ON	220,00
NS-OP-OL-BO-NO-SE-TE	270,00
NP-TO-FE-TU-CM-CL-NM AN-RU-CO-RO-PO-CE-CN	320,00
OO-OR	440,00

## ZC640102

Portasalviette l. 640 mm  
Towel holder mm 640 l.  
Porte-serviette mm 640

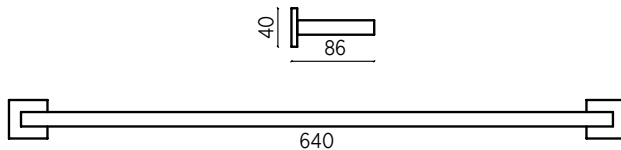

Finitura/finish/finition	€
CC-ON	240,00
NS-OP-OL-BO-NO-SE-TE	290,00
NP-TO-FE-TU-CM-CL-NM AN-RU-CO-RO-PO-CE-CN	340,00
OO-OR	440,00

## ZC640103

Portarotolo  
Toilet paper holder  
Porte papier hygiénique

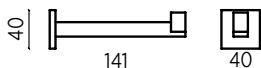

Finitura/finish/finition	€
CC-ON	155,00
NS-OP-OL-BO-NO-SE-TE	195,00
NP-TO-FE-TU-CM-CL-NM AN-RU-CO-RO-PO-CE-CN	235,00
OO-OR	310,00

## ZC640104

Appendino  
Hook  
Crochet

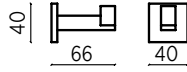

Finitura/finish/finition	€
CC-ON	110,00
NS-OP-OL-BO-NO-SE-TE	140,00
NP-TO-FE-TU-CM-CL-NM AN-RU-CO-RO-PO-CE-CN	165,00
OO-OR	220,00

## ZC640105

Porta sapone  
Soap dish  
Porte-savon

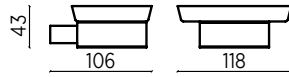

Finitura/finish/finition	€
CC-ON	220,00
NS-OP-OL-BO-NO-SE-TE	290,00
NP-TO-FE-TU-CM-CL-NM AN-RU-CO-RO-PO-CE-CN	330,00
OO-OR	440,00

## ZC640106

Dispenser sapone  
Soap dispenser  
Distributeur de savon

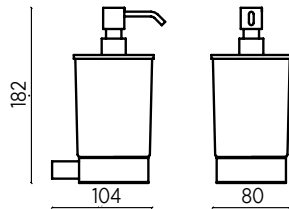

Finitura/finish/finition	€
CC-ON	220,00
NS-OP-OL-BO-NO-SE-TE	290,00
NP-TO-FE-TU-CM-CL-NM AN-RU-CO-RO-PO-CE-CN	330,00
OO-OR	440,00

## ZC640107

Porta spazzolino  
Toothbrush holder  
Porte-brosse WC

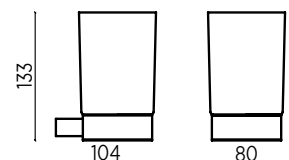

Finitura/finish/finition	€
CC-ON	170,00
NS-OP-OL-BO-NO-SE-TE	210,00
NP-TO-FE-TU-CM-CL-NM AN-RU-CO-RO-PO-CE-CN	245,00
OO-OR	320,00

Istruzioni installazione parti incasso | *Built-in parts installation instructions*

| Instructions d'installation des pièces intégrées



ZC0D2504GR  
ZC0D2507GR  
ZC0D3504GR  
ZC0D3505GR



ZC0D2505GR  
ZC0D2507GR  
ZC0D3506GR  
ZC0D3509GR



ZC0DEV01GR



ZC0D2501GR  
ZC0D2502GR  
ZC0D3501GR  
ZC0D3502GR



ZC0D2503GR  
ZC0D2506GR  
ZC0D3503GR  
ZC0D3508GR  
ZC0D3510GR



ZC0D3507GR



ZC0TRC01GR  
ZC0TRC02GR  
ZC0TRC03GR  
ZC0TRC05GR  
ZC0TRC06GR  
ZC0TRC07GR



ZC0TRC04GR  
ZC0TRC08GR

Legenda finiture | *Finishes key* | Légende des finitions

	<b>COLORE COLOUR COLEUR</b>	<b>RESISTENZA NEL TEMPO SENZA ALTERNAZIONI RESISTANCE OVER TIME WITHOUT ALTERATIONS RÉSISTANCE DANS LE TEMPS SANS ALTÉRATIONS</b>	<b>UTILIZZO ALL' ESTERNO OUTDOOR USE UTILISATION EN EXTÉRIEUR</b>
CC	CROMO	10	SI/YES/OUI
ON	OTTONE NATURALE	0	SI/YES/OUI
NS	NICHEL SPAZZOLATO	8	SI/YES/OUI
OP	OTTONE PROTETTO OPACO	9	SI/YES/OUI
OL	OTTONE PROTETTO LUCIDO	9	SI/YES/OUI
BO	BIANCO OPACO	10	SI/YES/OUI
NO	NERO OPACO	10	SI/YES/OUI
SE	SENAPE	10	SI/YES/OUI
TE	TERRACOTTA	10	SI/YES/OUI
NP	NICHEL SPAZZOLATO PROTETTO OPACO	9	SI/YES/OUI
TO	BRONZO PROTETTO OPACO	9	SI/YES/OUI
RO	RAME PROTETTO OPACO	9	SI/YES/OUI
FE	FERRO	7	SI/YES/OUI
TU	TUSCAN	10	SI/YES/OUI
CM	CARAMELLO	6	SI/YES/OUI
CL	COLORI RAL	10	SI/YES/OUI
NM	NERO MARTELLATO	10	SI/YES/OUI
AN	ANTRACITE	10	SI/YES/OUI
RU	RUGGINE	10	SI/YES/OUI
CO	CORTEN	10	SI/YES/OUI
PO	POMPEI	10	SI/YES/OUI
CE	CEMENTO	10	SI/YES/OUI
CN	CANNELLA	10	SI/YES/OUI
OO	ORO	8	NO
OR	ORO ROSA	8	NO

**Pulizia | *Cleaning* | Nettoyage**

**Attenzione:** Si raccomanda di utilizzare per la pulizia del rubinetto, sempre e solo, acqua, sapone neutro e spugna morbida non abrasiva.

**Attention:** It is recommended, to use for the cleaning of the tap, always, water, neutral soap and non-abrasive soft sponge.

**Attention:** Nous recommandons d'utiliser pour nettoyer le robinet, toujours et uniquement, de l'eau, du savon neutre et une éponge douce non abrasive.



Zanetti Chini si riserva il diritto di apportare le modifiche che ritiene opportune ad articoli, finiture e misure al fine di migliorare il prodotto.

Le illustrazioni contenute nel presente depliant non comportano obbligo di fedele riproduzione.

*Zanetti Chini reserves the right to make any changes it deems appropriate to articles, finishes and measures in order to improve the product.*

*The illustrations in this brochure not entail obligation to faithful reproduction.*

Zanetti Chini se réserve le droit de faire les modifications qu'il juge opportunes d'articles, de finitions et de tailles afin d'améliorer le produit.

Les illustrations contenues dans cette brochure n'impliquent pas une obligation de reproduction fidèle.

Photo: Alberto Aliverti\_ Whiterobot

Grafica: Barbara Dapas\_ Punto a capo



Via Brughiere, 15  
28017 San Maurizio D'opaglio (NO) - IT  
tel. +39 0322.950.043 - fax +39 0322 950.042  
info@zanettichini.it - www.zanettichini.it