

KERASAN

PIATTI DOCCIA E BOX DOCCIA

SHOWER TRAYS AND SHOWER ENCLOSURES



KERASAN

PIATTI DOCCIA E BOX DOCCIA

SHOWER TRAYS AND SHOWER ECLOSURES

PIATTI DOCCIA

SHOWER TRAYS

- 02 piatti doccia in / shower trays in **CERAMICA "PEEL"** H. 3
- 10 piatti doccia in / shower trays in **CERAMICA** H. 3
- 12 piatti doccia in / shower trays in **CERAMICA** H. 6
- 14 piatti doccia in / shower trays in **MARMORESINA** H. 2,5
- 22 piatti doccia in / shower trays in **ACRILICO** H. 3

BOX DOCCIA

SHOWER ENCLOSURES

- 32 **FLEX**
- 36 **8PAR53**
- 38 **FPSC50**
- 42 **8PSC15**
- 46 **PSCRAPID**
- 50 **RAPID**

KERASAN

piatti doccia h3
in **CERAMICA "PEEL"**



piatti doccia h3
in **CERAMICA "PEEL"**

PEEL è il nuovo piatto doccia in ceramica H3 disponibile in 4 colorazioni studiate con tonalità che permettono di essere inserite in modo armonioso in tutti gli ambienti bagno, inoltre grazie allo spessore di soli 3 cm è installabile sia in appoggio che filo pavimento.

La ceramica, materiale pregiato assicura ottima resistenza ai graffi ed al calcare e permette di essere tagliata su misura a seconda delle esigenze.

A completare la gamma troviamo gli accessori coordinati di altissima qualità come la speciale piletta Geberit con griglia in acciaio Inox o nelle finiture in tinta con il piatto doccia, permettendo così di giocare con gli abbinamenti per raggiungere il massimo risultato estetico.

PEEL is the new ceramic shower tray which is only 3 cm high and available in four colours in order to blend in harmoniously with any bathroom environment, thanks also to its ultra slim low-level design suitable for installation on top or flush with the floor.

As a high-quality material, the shower tray in ceramic ensures excellent resistance to scratches and limescale and can be cut to size as required.

The range of this collection can be completed with matching accessories of the highest quality, such as the grid drain plug by Geberit in stainless steel or in a shade which matches the shower tray, allowing you to play with combinations of colours and to achieve the best aesthetic result.

Finiture - Finishing

cod. 30

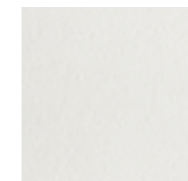

bianco matt
matt white

cod. 65



avorio
ivory

cod. 59

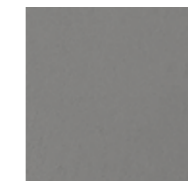

cemento
concrete

cod. 31

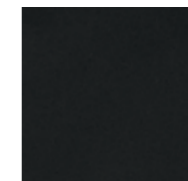

nero matt
matt black

Piletta geberit - Piletta geberit



art. 936201

Piletta Geberit
ultrasottile bianca

*Geberit ultra-flat
white drain plug*

Ø 90 mm.

Griglie - Griglie



art. 936230
bianco matt
matt white

125 X 125 mm



art. 936265
avorio
ivory

125 X 125 mm



art. 936259
cemento
concrete

125 X 125 mm



art. 936231
nero matt
matt black

125 X 125 mm



art. 936290
acciaio inox
stainless steel

125 X 125 mm

piatti doccia h3
in **CERAMICA "PEEL"**



H 3 piatti doccia ceramica "Peel" ceramic "Peel" shower trays

CARATTERISTICHE CHARACTERISTICS

ANTIMACCHIA
STAIN RESISTANT



SEMPLICE DA PULIRE
SIMPLE TO CLEAN



SUPERFICIE ANTIBATTERICA
ANTIBACTERIAL SURFACE

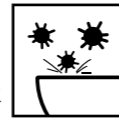

RESISTENTE AGLI ACIDI, ALCALI
RESISTANT TO ACIDS, ALKALIS

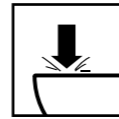

ANTISCIVOLO
NON-SLIP

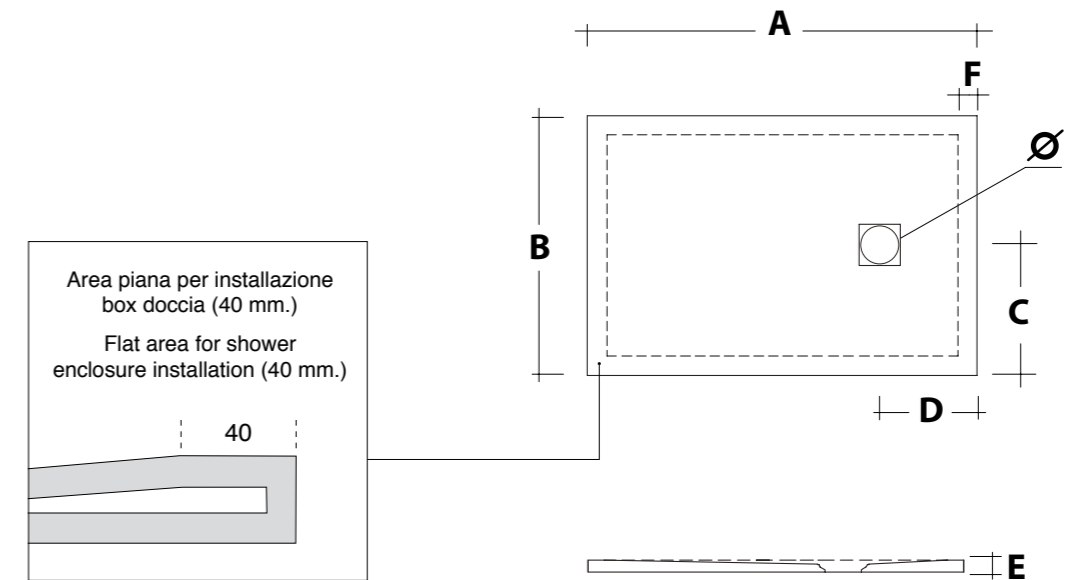
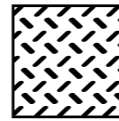

TAGLI SU MISURA MADE TO MEASURE CUTS

COMPLETAMENTE REVERSIBILE,
SMALTO SU 4 LATI
COMPLETELY REVERSIBLE,
GLAZED ON THE 4 SIDES

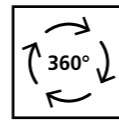

RIDUCIBILE/TAGLIABILE
REDUCIBLE/CUTTABLE

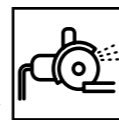

**Versatilità totale,
per adattarsi
ad ogni spazio**

Grazie ai bordi smaltati sui 4 lati che garantiscono l'adattabilità in ogni tipologia di area doccia. Inoltre i piatti doccia Peel sono riducibili, quindi possono essere tagliati su misura, per adattarsi con facilità a qualsiasi progetto bagno.

**Total versatility,
to suit to any
space**

The glaze edges on the 4 sides that provide adaptability in any type of shower tray area. The Peel shower tray is reducible, it can be customized cut, to easily adapt to any bathroom project.

		A	B	C	D	E	Ø	F
art. 7063	piatto doccia 70 x 100	1000	700	350	250	30	90	40
art. 7064	piatto doccia 70 x 120	1200	700	350	300	30	90	40
art. 7065	piatto doccia 70 x 140	1400	700	350	350	30	90	40
art. 7066	piatto doccia 80 x 100	1000	800	400	250	30	90	40
art. 7067	piatto doccia 80 x 120	1200	800	400	300	30	90	40
art. 7068	piatto doccia 80 x 140	1400	800	400	350	30	90	40

piatti doccia h3
in **CERAMICA**



piatti doccia h. 3
in **CERAMICA**

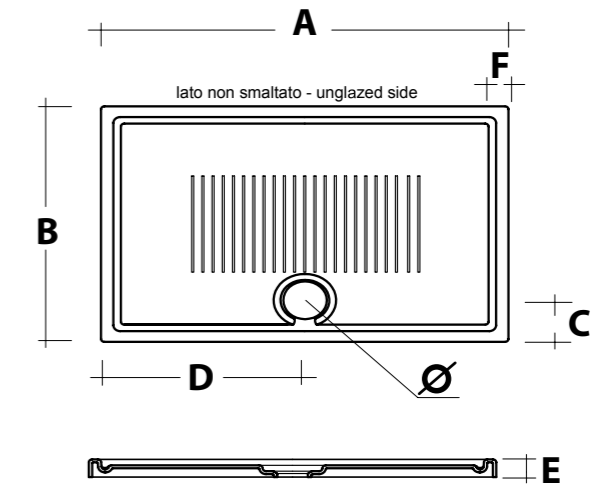

		A	B	C	D	E	Ø	F
art. 709201 piatto doccia	90 x 70	900	700	145	450	30	90	40
art. 709301 piatto doccia	80 x 80	800	800	145	400	30	90	40
art. 709401 piatto doccia	100 x 70	1000	700	145	500	30	90	40
art. 709501 piatto doccia	100 x 80	1000	800	145	500	30	90	40
art. 709601 piatto doccia	120 x 70	1200	700	145	600	30	90	40
art. 709701 piatto doccia	120 x 80	1200	800	145	600	30	90	40
art. 709801 piatto doccia	140 x 70	1400	700	145	700	30	90	40
art. 709901 piatto doccia	140 x 80	1400	800	145	700	30	90	40

Finiture - Finishing

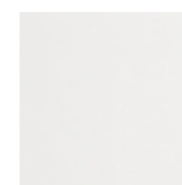

bianco lucido
glossy white

Piletta geberit - Piletta geberit



art. **926001**
Piletta Geberit ultrasottile
con tappo bianco
Geberit ultra-flat drain
plug with white cover
Ø 90 mm.

piatti doccia h6
in **CERAMICA**



piatti doccia h. 6
in **CERAMICA**

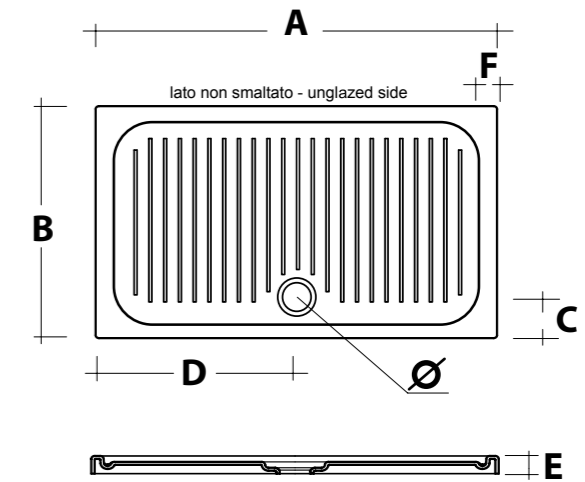

		A	B	C	D	E	Ø	F
art. 715001	piatto doccia 80 x 80	800	800	145	400	60	90	50
art. 715101	piatto doccia 90 x 90	900	900	145	450	60	90	50
art. 715201	piatto doccia 90 x 72	900	720	145	450	60	90	50
art. 715301	piatto doccia 100 x 70	1000	700	145	500	60	90	50
art. 715401	piatto doccia 120 x 70	1200	700	145	600	60	90	50
art. 715501	piatto doccia 100 x 80	1000	800	145	500	60	90	50
art. 715601	piatto doccia 120 x 80	1200	800	145	600	60	90	50
art. 715701	piatto doccia 140 x 80	1400	800	145	700	60	90	50

Finiture - Finishing



bianco lucido
glossy white

Piletta geberit - Piletta geberit



art. 926001
Piletta Geberit ultrasottile
con tappo bianco
Geberit ultra-flat drain
plug with white cover
Ø 90 mm.

piatti doccia h2.5 in **MARMORESINA**

Il piano inclinato facilita lo scorrimento dell'acqua e con soli 25 mm di altezza si adatta all'installazione sia filo pavimento che sopra pavimento.

The slope permits excellent draining and with a total height of 25 mm the shower tray may be installed normally on the bathroom floor or sunk in level with the flooring.

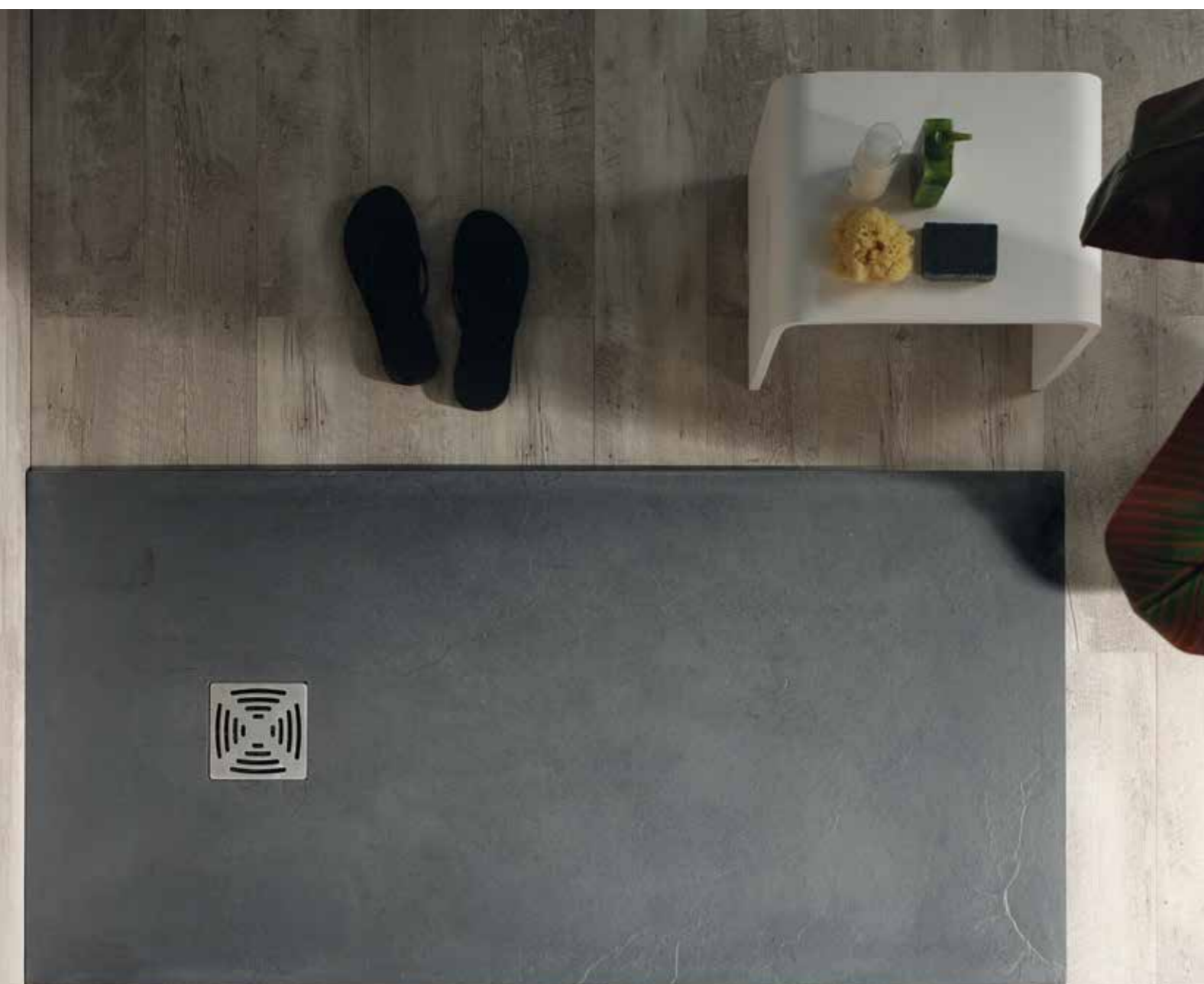

Installazione del piatto doccia a filo pavimento.
The shower tray can be installed flush to the flooring.

piatti doccia h2.5 in **MARMORESINA**



piatti doccia h2.5
in **MARMORESINA**



piatti doccia h2.5
in **MARMORESINA**

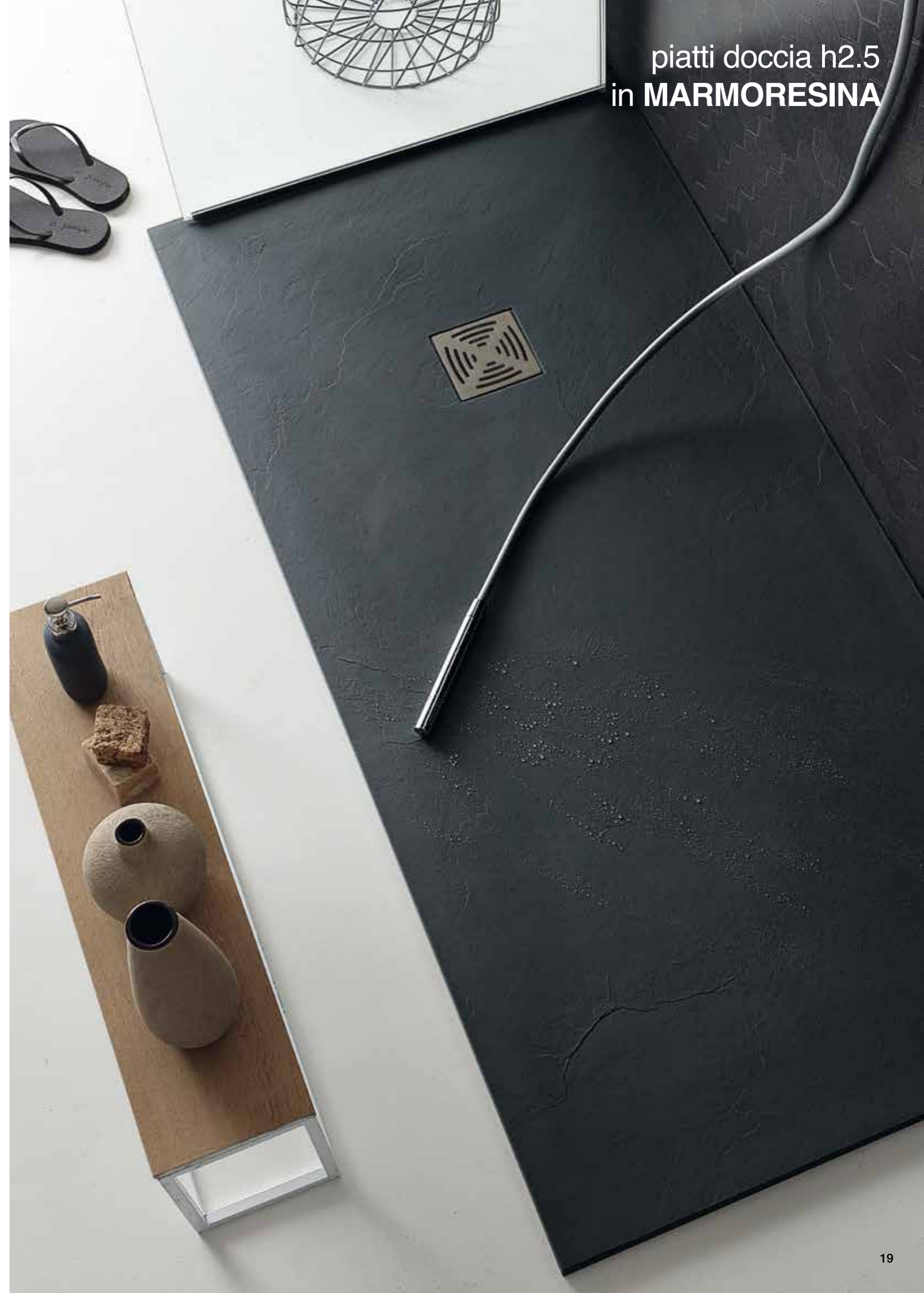

piatti doccia h2.5 in **MARMORESINA**

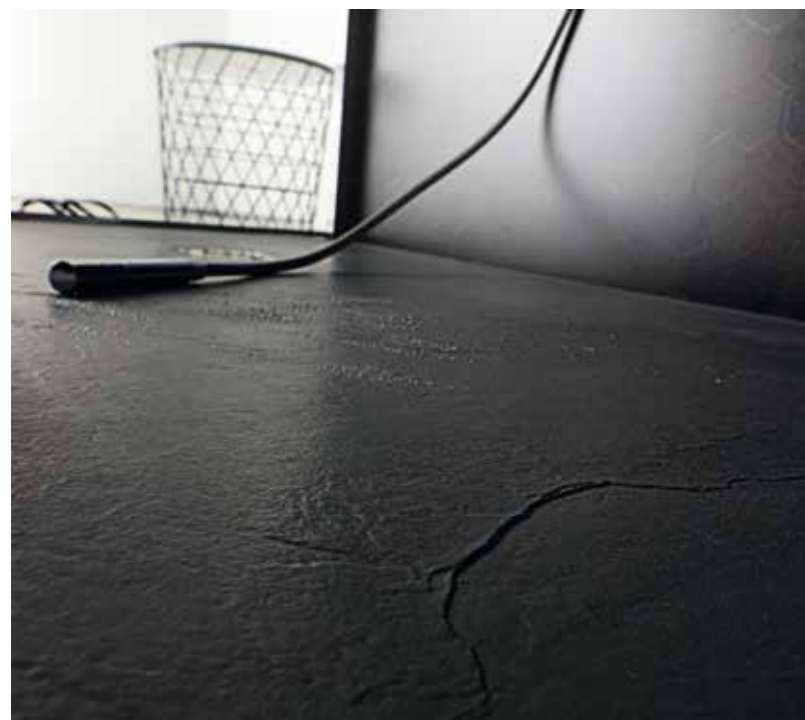

PIATTI DOCCIA IN MARMORESINA

La resina miscelata con minerali garantisce elevate prestazioni tecniche e strutturali ed è ideale sia per ambienti interni che esterni. L'impasto è totalmente pigmentato: ciò significa che l'interno del prodotto e la superficie del piatto doccia hanno lo stesso colore. Il piano inclinato facilita lo scorrimento dell'acqua e con soli 25 mm di altezza si adatta all'installazione sia filo pavimento che sopra pavimento. La superficie è antiscivolo con trama pietra.

Il prodotto è adattabile anche per installazioni in fuori squadra, in quanto è di facile taglio con disco apposito.

Il piatto doccia viene fornito completo di piletta di scarico e copertura piletta in acciaio inossidabile.

MARBLE-RESIN SHOWER TRAYS

Resin mixed together with minerals guarantees mechanical high-performance and aesthetic features. The shower trays can be installed inside or outdoors. The shower tray body is pigmented in the same color as the shower tray surface, it is anti-slip and it reproduces a stone surface.

The shower trays can be installed in out of square corners.

The trays can be cut by using the appropriate cutting tool. The slope permits excellent draining and with a total height of 25 mm the shower tray may be installed normally on the bathroom floor or sunk in level with the flooring. The shower tray comes complete with siphon and stainless steel drain cover.

Finiture - Finishing

cod. 30

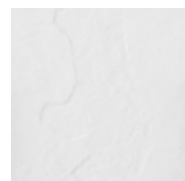

bianco matt
matt white

cod. 54

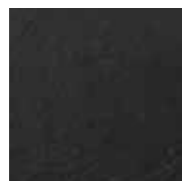

antracite
anthracite

cod. 59



grigio matt
matt grey

cod. 65



crema matt
matt cream

piatti doccia h2.5 in **MARMORESINA**



H25 Piatti doccia marmoresina marble-resin shower trays

Dimensioni cm Dimensions cm	Codice Code
80 x 80 x h 2,5	7030
90 x 90 x h 2,5	7031

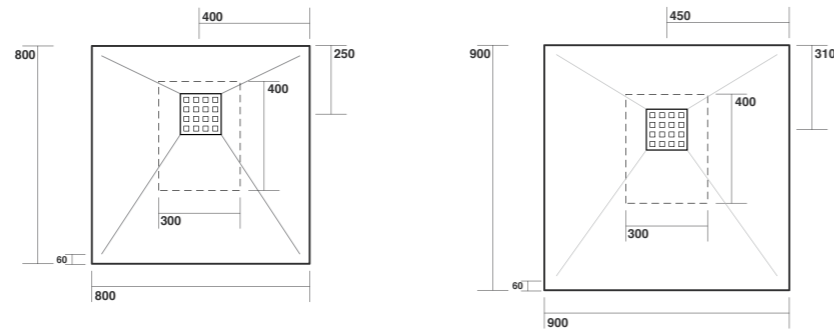

72 x 90 x h 2,5	7032
-----------------	------

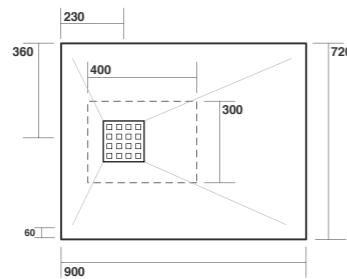

70 x 100 x h 2,5	7033
70 x 120 x h 2,5	7034
70 x 140 x h 2,5	7035
80 x 100 x h 2,5	7039
80 x 120 x h 2,5	7040
80 x 140 x h 2,5	7041
90 x 100 x h 2,5	7057
90 x 120 x h 2,5	7058
90 x 140 x h 3	7059

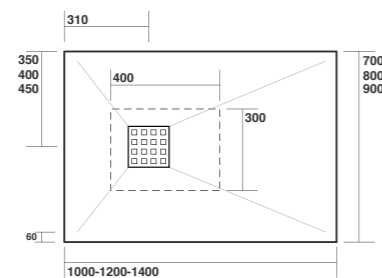

70 x 160 x h 2,5	7036
70 x 170 x h 2,5	7037
70 x 180 x h 2,5	7038
80 x 160 x h 2,5	7042
80 x 170 x h 2,5	7043
80 x 180 x h 2,5	7044
90 x 160 x h 3	7060
90 x 170 x h 3	7061
90 x 180 x h 3	7062

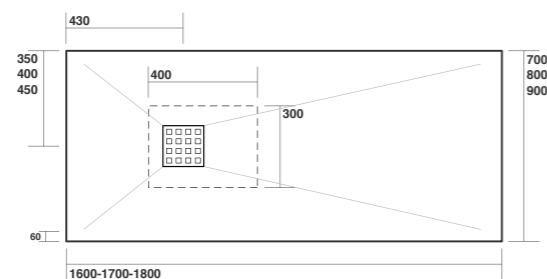

H25 Piatti doccia marmoresina marble-resin shower trays

Dimensioni cm Dimensions cm	Codice Code
80 x 80 x h 2,5	7045
90 x 90 x h 2,5	7046

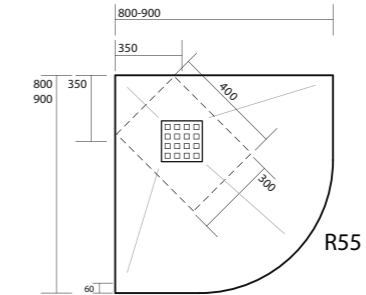

istallazione in appoggio
free standing shower tray

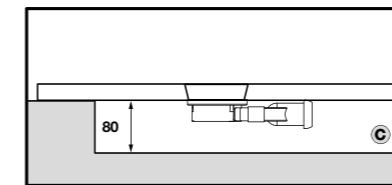

istallazione filo pavimento
floor level shower tray

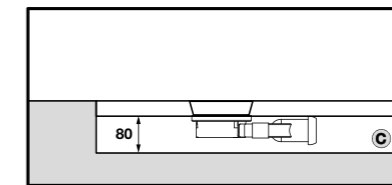

Ⓢ IT Area consigliata per lo scarico a pavimento
EN Recommended space for floor-mounted drain

Piletta sifonata Ø 90 mm per piatti doccia
Drain plug Ø 90 mm for shower trays



piatti doccia H3
in **ACRILICO**



piatti doccia H3
in **ACRILICO**

Caratteristiche tecniche dell'antiscivolo:

il sistema antiscivolo consiste nell'applicazione sul piatto doccia in Acrilico di vernice epossidica-acrilica dalle alte prestazioni, con finitura lucida brillante e molto resistente alle macchie. Consente una facile pulizia del piatto anche con prodotti e detergenti chimici casalinghi, industriali e resistente alla pulizia a vapore.

Anti-slip technical features:

The anti-slip system consists of the application of high performing acrylic epoxy paint on the shower tray. This paint has a polished shiny surface and is very resistant to stains. It makes cleaning of the tray easier, is suitable for the use of household and industrial chemical detergents and is resistant to steam cleaning.



piatti doccia H3
in **ACRILICO**



piatti doccia H3
in **ACRILICO**



Caratteristiche del Piatto Doccia in Acrilico h3:

- Realizzato in pregiato Acrilico Antibatterico che non ingiallisce nel tempo.
- Rinforzato con doghe in legno affogato nella vetroresina assicura una maggiore robustezza.
- Piletta ispezionabile ribassata (meno di 6cm di altezza) con diametro 9cm permette di scaricare 25 litri al minuto.
- Facile installazione sia versione in appoggio che a filo pavimento.

Features of the h3 Acrylic Shower Tray:

- Made of high-quality Antibacterial Acrylic that does not turn yellow over time.
- More robust thanks to reinforced with wooden slats drowned in fibreglass.
- Lowered 9cm diameter drain that can be inspected (less than 6cm high) and that enables to drain 25 litres per minute.
- Easily installation both for top mount and floor level installations.

H3 Piatti doccia in acrilico acrylic shower trays

Descrizione Description	Dimensioni cm Dimensions cm	Codice Code	Antiscivolo Anti-slip
----------------------------	--------------------------------	----------------	--------------------------

Piatto doccia in ACRILICO h3 bianco completo di piletta.
White acrylic shower tray h3 whit drain pipe.

80 x 80 x h 3	704701	704901
90 x 90 x h 3	704702	704902
100 x 100 x h 3	704703	704903

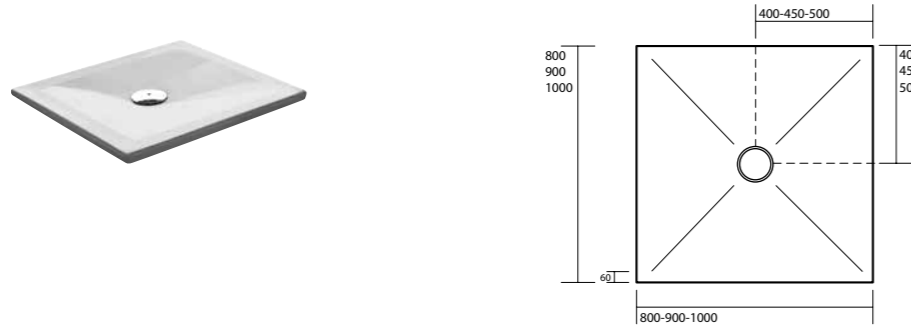

istallazione in appoggio
free standing shower tray

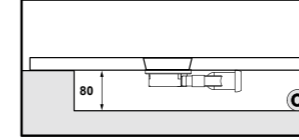

istallazione filo pavimento
floor level shower tray

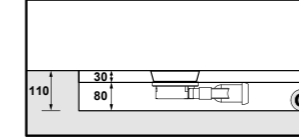

C IT Area consigliata per lo scarico a pavimento
EN Recommended space for floor-mounted drain

Piatto doccia in ACRILICO h3 bianco completo di piletta.
White acrylic shower tray h3 whit drain pipe.

72 x 90 x h 3	704704	704904
70 x 100 x h 3	704705	704905
70 x 120 x h 3	704706	704906
70 x 140 x h 3	704707	704907
70 x 160 x h 3	704708	704908
70 x 170 x h 3	704709	704909
80 x 100 x h 3	704710	704910
80 x 120 x h 3	704711	704911
80 x 140 x h 3	704712	704912
80 x 160 x h 3	704713	704913
80 x 170 x h 3	704714	704914

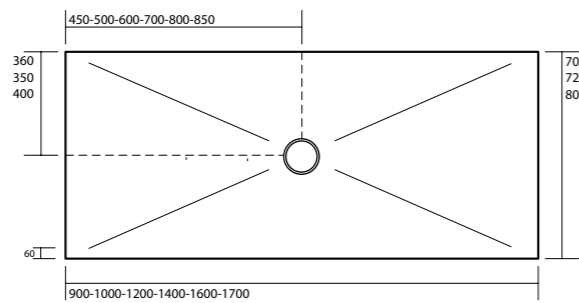

80x80
90x90
100x100

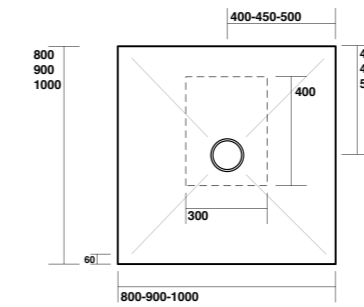

72x90
70x100 70x120 70x140 70x160 70x170
80x100 80x120 80x140 80x160 80x170

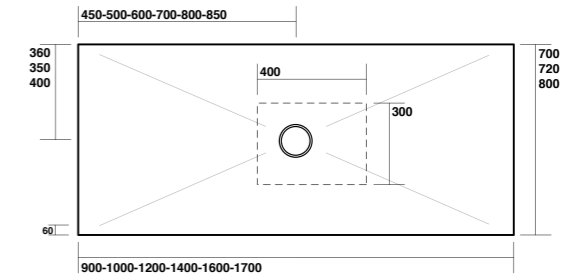

istallazione in appoggio
free standing shower tray



istallazione filo pavimento
floor level shower tray



Piatto doccia angolo in ACRILICO h3 bianco completo di piletta.
Corner white acrylic shower tray h3 whit drain pipe.

80 x 80 x h 3	704715	704915
90 x 90 x h 3	704716	704916
100 x 100 x h 3	704717	704917

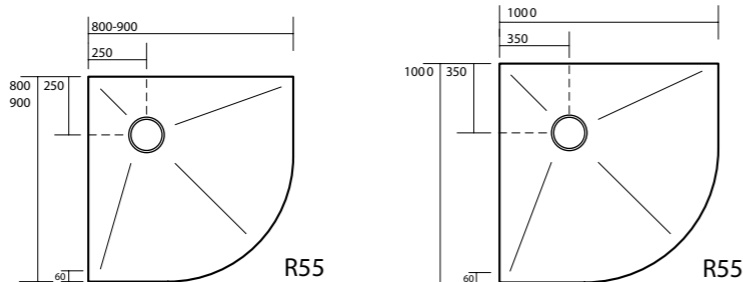

80x80
90x90

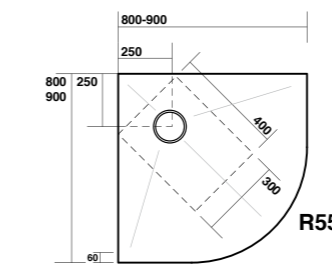

100x100

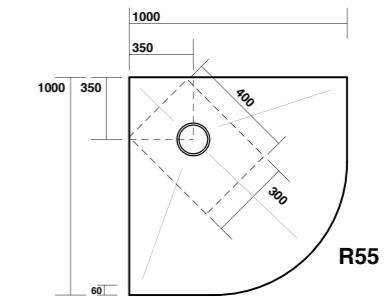

istallazione in appoggio
free standing shower tray



istallazione filo pavimento
floor level shower tray

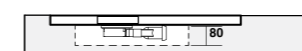

Piletta sifonata Ø 90 mm per piatti doccia
Drain plug Ø 90 mm for shower trays

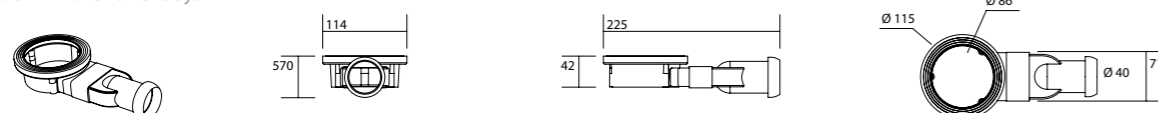



7457
Porta FLEX
Sliding door FLEX



7458
Parete doccia 8PAR53
Shower wall 8PAR53



7455
Porta FPSC50
Sliding door FPSC50



7461
Porta 8PSC15
Sliding door 8PSC15



7459
Porta PSCRAPID
Sliding door PSCRAPID



7460
Porta RAPID
Sliding door RAPID



745701
Porta scorrevole FLEX 70
Sliding door FLEX 70

745705
Porta scorrevole FLEX 90
Sliding door FLEX 90

9231
Kit doccia
Mixer shower faucer kit





FLEX

Porte scorrevoli / Sliding doors **H 2000 mm**

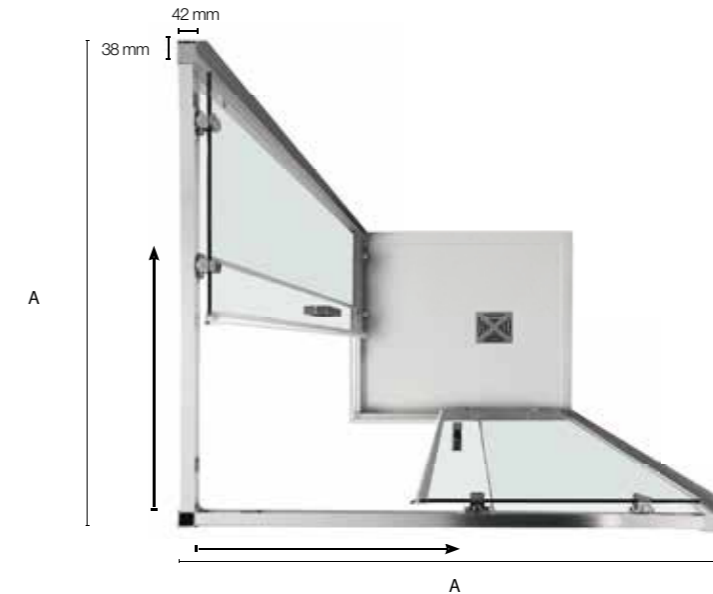
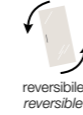

Versione angolare DX
Right corner version

APERTURA PORTA OPENING DOOR

FLEX MM	700	720	750	800	900	1000	1100	1200	1300	1400
700	331	338	349	368	408	450	493	538	583	629
720	338	345	356	374	414	455	498	542	587	633
750	349	356	366	384	423	463	505	549	594	639
800	368	374	384	402	438	478	519	561	605	649
900	408	414	423	438	472	509	548	588	630	673
1000	450	455	463	478	509	543	580	618	658	699
1100	493	498	505	519	548	580	614	650	688	728
1200	538	542	549	561	588	618	650	685	721	759
1300	583	587	594	605	630	658	688	721	755	791
1400	629	633	639	649	673	699	728	759	791	826

SINGOLO LATO PORTA SCORREVOLE (A) SLIDING DOOR SINGLE SIDE (A)

Specifiche tecniche / Technical specifications			
P/D mm	H/H mm	Peso vetro kg Glass weight kg	Estensibilità mm Extension mm
700	2000	23	665 - 690
720	2000	24	685 - 710
750	2000	25	715 - 740
800	2000	26	765 - 790
900	2000	29	865 - 890
1000	2000	32	965 - 990
1100	2000	36	1065 - 1090
1200	2000	39	1165 - 1190
1300	2000	42	1265 - 1290
1400	2000	45	1365 - 1390

8PAR53

Soluzione aperta / Open solution H 2030 mm

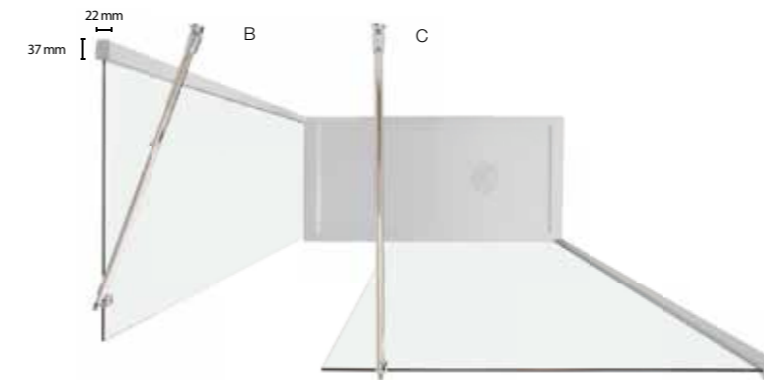

Versione 8PAR53 da 1100 mm + lato 8PAR53 da 700 mm
8PAR53 Version mm 1100 + side 8PAR53 mm 700

Versione 8PAR53
8PAR53 Version

(B) L'estensibilità dell'asta di fissaggio varia da 500 mm fino a 800 mm
(B) The extension of the support arm can vary from 500 mm to 800 mm

(C) L'estensibilità dell'asta di fissaggio varia da 710 mm fino a 1200 mm
(C) The extension of the support arm can vary from 710 mm to 1200 mm

SINGOLO LATO SINGLE SIDE PANEL

Specifiche tecniche / Technical specifications

Dimensioni (A) / Sizes (A)					
L/W mm	H/H mm	Peso vetro kg Glass weight kg	Estensibilità mm Extension mm	Estensibilità asta di fissaggio di serie mm (B) Extension of the standard support arm mm (B)	Estensibilità asta di fissaggio di serie mm (C) Extension of the standard support arm mm (C)
700	2030	39	680 - 700	500 - 800	-
800	2030	44	780 - 800	500 - 800	-
900	2030	49	880 - 900	500 - 800	-
1000	2030	53	980 - 1000	-	710 - 1200
1100	2030	58	1080 - 1100	-	710 - 1200
1200	2030	63	1180 - 1200	-	710 - 1200
1300	2030	68	1280 - 1300	-	710 - 1200
1400	2030	73	1380 - 1400	-	710 - 1200



745602

Lato fisso FPSC50 80
Fixed side panel FPSC50 80

745503

Porta scorrevole FPSC50 120
Sliding door FPSC50 120

FPSC50

Porta scorrevole / Sliding door H 2000 mm

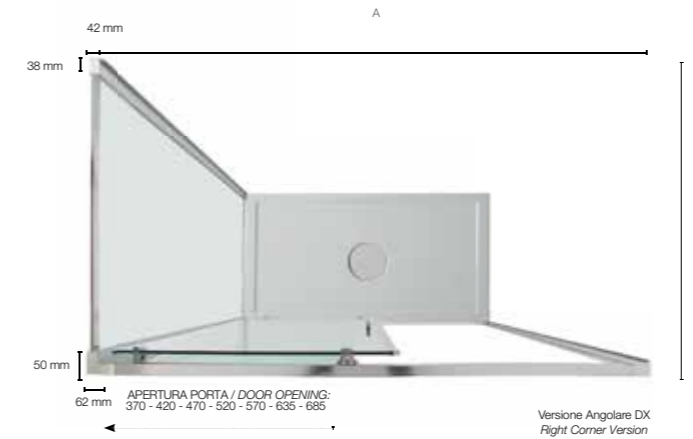

PORTA ABBINATA A LATO FISSO DOOR MATCHED WITH FIXED PANEL

Specifiche tecniche / Technical specifications		
P/D	H/H	Estensibilità mm
mm	mm	Extension mm
1000	2000	962 - 1010
1100	2000	1062 - 1110
1200	2000	1162 - 1210
1300	2000	1262 - 1310
1400	2000	1362 - 1410
1500	2000	1462 - 1510
1600	2000	1562 - 1610
1700	2000	1662 - 1710
1800	2000	1762 - 1810

DIMENSIONI LATO FISSO (B) FISSO FIXED SIDE PANEL SIZE (B) FISSO

Specifiche tecniche / Technical specifications			
P/D	H/H	Peso vetro kg	Estensibilità mm
mm	mm	Glass weight kg	Extension mm
700	2000	24	665 - 715
800	2000	27	765 - 815
900	2000	30	865 - 915
1000	2000	34	965 - 1015

DIMENSIONI PORTA (A) (NICCHIA) DOOR SIZES (A) (NICHE)

Specifiche tecniche / Technical specifications				
L/W	H/H	Peso vetro kg	Apertura porta	Estensibilità mm
mm	mm	Glass weight kg	Door opening	Extension mm
1000	2000	35	370	950 - 1000
1100	2000	38	420	1050 - 1100
1200	2000	40	470	1150 - 1200
1300	2000	43	520	1250 - 1300
1400	2000	46	570	1350 - 1400
1500	2000	50	635	1450 - 1500
1600	2000	53	685	1550 - 1600
1700	2000	56	685	1650 - 1700
1800	2000	59	685	1750 - 1800

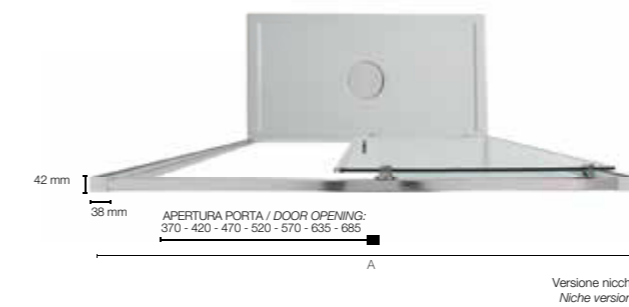

8PSC15

8PSC15 è un sistema cabina doccia ad anta scorrevole con telaio in alluminio lucido e vetro 8mm. Il modello esteticamente pulito, presenta un profilo squadrato e dettagli minimali ed eleganti come l'aggancio dei vetri e la maniglia.

8PSC15 is a shower enclosure system with sliding door, polished aluminum frame and 8mm glass. The model is aesthetically clean, it has a square aluminum profile and other minimalistic and elegant details such as the way the glass doors attach and the handle.



8PSC15

Porta scorrevole / Sliding door H 2000 mm



VERSIONE: ANGOLARE E NICCHIA

VERSION: CORNER AND NICHE



NTPA06
Profilo di allungamento
Adjustable profile
+ 15 mm



Cristallo trasparente
Transparent glass



APERTURA PORTA / DOOR OPENING:
390 - 440 - 490 - 540 - 590 - 640 - 690

A

Versione nicchia
Niche Version



APERTURA PORTA / DOOR OPENING:
390 - 440 - 490 - 540 - 590 - 640 - 690

A

Versione Angolare DX da 1000 mm
Right Corner Version 1000 mm

DIMENSIONI PORTA (A) (NICCHIA) DOOR SIZE (A) (NICHE)

Specifiche tecniche / Technical specifications				
L/W mm	H/H mm	Peso vetro kg Glass weight kgs	Apertura porta Door Opening	Estensibilità mm Extension mm
1000	2000	51	390	970 - 995
1050	2000	53	390	1020 - 1045
1100	2000	56	440	1070 - 1095
1150	2000	59	440	1120 - 1145
1200	2000	61	490	1170 - 1195
1250	2000	63	490	1220 - 1245
1300	2000	66	540	1270 - 1295
1350	2000	69	540	1320 - 1345
1400	2000	71	590	1370 - 1395
1450	2000	75	590	1420 - 1445
1500	2000	76	640	1470 - 1495
1550	2000	79	640	1520 - 1545
1600	2000	81	690	1570 - 1595
1650	2000	84	690	1620 - 1645
1700	2000	86	690	1670 - 1695
1750	2000	89	690	1720 - 1745
1800	2000	91	690	1770 - 1795

PORTA ABBINATA A LATO FISSO DOOR MATCHED WITH FIXED PANEL

Specifiche tecniche / Technical specifications		
P/D mm	H/H mm	Estensibilità mm Extension mm
1000	2000	970 - 995
1050	2000	1020 - 1045
1100	2000	1070 - 1095
1150	2000	1120 - 1145
1200	2000	1170 - 1195
1250	2000	1220 - 1245
1300	2000	1270 - 1295
1350	2000	1320 - 1345
1400	2000	1370 - 1395
1450	2000	1420 - 1445
1500	2000	1470 - 1495
1550	2000	1520 - 1545
1600	2000	1570 - 1595
1650	2000	1620 - 1645
1700	2000	1670 - 1695
1750	2000	1720 - 1745
1800	2000	1770 - 1795

DIMENSIONI LATO FISSO (B) FIXED SIDE PANEL SIZE (B)

Specifiche tecniche / Technical specifications			
P/D mm	H/H mm	Peso vetro kg Glass weight kgs	Estensibilità mm Extension mm
700	2000	37	680-705
800	2000	42	770-795
900	2000	47	870-895

PSCRAPID

PSCRAPID è una cabina doccia con anta scorrevoli h. 2000 mm. La struttura con profili neri delinea gli spazi in maniera caratterizzante, esaltando così la leggerezza e la trasparenza del vetro.

PSCRAPID is a h2000 mm shower cubicle with sliding doors. The structure with black profiles strongly outlines spaces, highlighting the glass lightness and transparency.



PSCRAPID

Porta scorrevole / Sliding door H 2000 mm



VERSIONE: ANGOLARE, CENTRO PARETE E NICCHIA

VERSION: CORNER, CENTER WALL AND NICHE

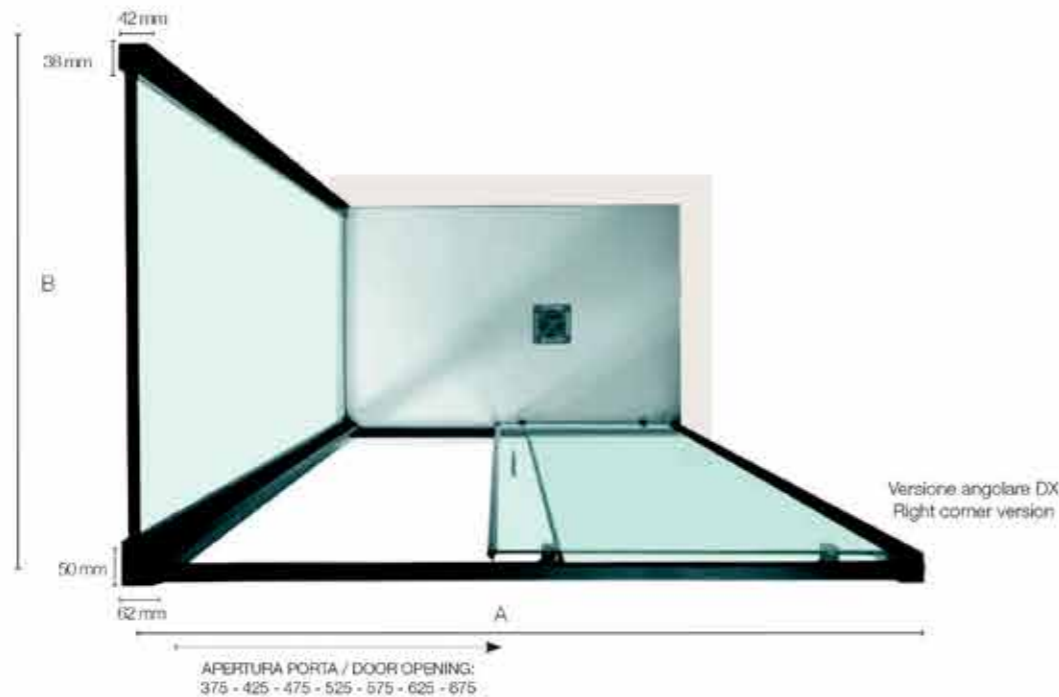

APERTURA PORTA / DOOR OPENING:
375 - 425 - 475 - 525 - 575 - 625 - 675

Versione angolare DX
Right corner version



Versione nicchia
Niche version

DIMENSIONI PORTA (A) (NICCHIA) DOOR SIZES (A) (NICHE)

Specifiche tecniche / Technical specifications				
L/W	H/H	Peso vetro kg	Apertura porta	Estensibilità mm
mm	mm	Glass weight kgs	Door opening	Extension mm
1000	2000	36	375	950-1000
1100	2000	38	425	1050-1100
1200	2000	40	475	1150-1200
1300	2000	43	525	1250-1300

Specifiche tecniche / Technical specifications				
L/W	H/H	Peso vetro kg	Apertura porta	Estensibilità mm
mm	mm	Glass weight kgs	Door opening	Extension mm
1400	2000	46	575	1350-1400
1500	2000	50	625	1450-1500
1600	2000	53	675	1550-1600
1700	2000	56	675	1650-1700

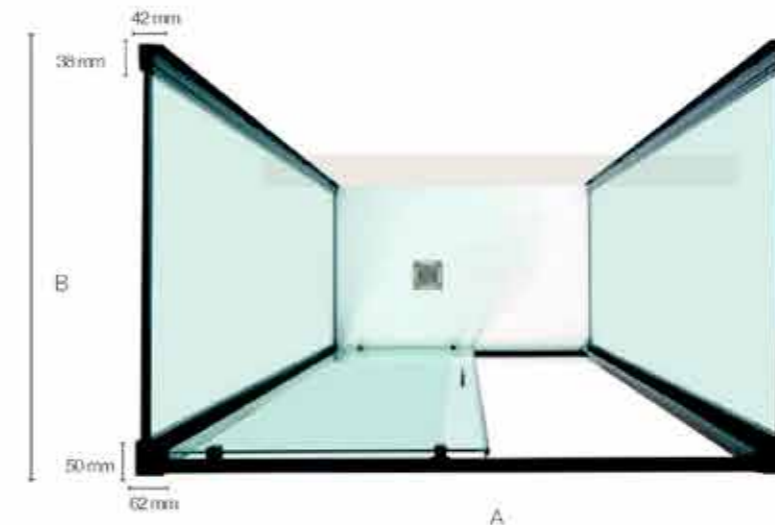

APERTURA PORTA / DOOR OPENING:
375 - 425 - 475 - 525 - 575 - 625 - 675

Apertura DX
Right opening door

Versione centro parete
Center wall version

PORTA ABBINATA A LATO FISSO DOOR MATCHED WITH FIXED PANEL

Specifiche tecniche / Technical specifications			
P/D	H/H	Peso vetro kg	Estensibilità mm
mm	mm	Glass weight kgs	Extension mm
1000	2000	36	962-1010
1100	2000	38	1062-1110
1200	2000	40	1162-1210
1300	2000	43	1262-1310
1400	2000	46	1362-1410
1500	2000	50	1462-1510
1600	2000	53	1562-1610
1700	2000	56	1662-1710

DIMENSIONI LATO FISSO (B) FIXED SIDE PANEL SIZE (B)

Specifiche tecniche / Technical specifications			
P/D	H/H	Peso vetro kg	Estensibilità mm
mm	mm	Glass weight kgs	Extension mm
700	2000	24	685-715
800	2000	27	765-815
900	2000	30	865-915

PORTA ABBINATA A 2 LATI FISSI DOOR MATCHED WITH 2 FIXED PANELS

Specifiche tecniche / Technical specifications		
P/D	H/H	Estensibilità mm
mm	mm	Extension mm
1000	2000	974-1020
1100	2000	1074-1120
1200	2000	1174-1220
1300	2000	1274-1320
1400	2000	1374-1420
1500	2000	1474-1520
1600	2000	1574-1620
1700	2000	1674-1720

DIMENSIONI LATO FISSO (B) FIXED SIDE PANEL SIZE (B)

Specifiche tecniche / Technical specifications			
P/D	H/H	Peso vetro kg	Estensibilità mm
mm	mm	Glass weight kgs	Extension mm
700	2000	24	685-715
800	2000	27	765-815
900	2000	30	865-915



RAPID

RAPID è un box doccia ad ante scorrevoli, un sistema semplice ma ricco di tecnologia ed esperienza, grazie soprattutto all'innovativo sistema di installazione rapida.

RAPID is a shower stall with sliding doors, a simple system but rich in technology and experience, thanks above all to the innovative quick installation system.



RAPID

Singolo lato per box doccia scorrevole / Single sliding panel for shower box **H 2000 mm**

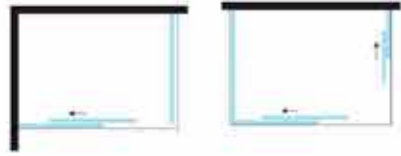

VERSIONE: ANGOLARE E CENTRO PARETE

VERSION: CORNER AND CENTER WALL



altezza height



reversibile reversible



easy clean easy clean



regolazione adjustment



finitura nero matt black matt finish



cristallo temperato tempered glass



TPAF08NE Profilo di allungamento Adjustable profile + 30 mm



Cristallo trasparente Transparent glass



Versione angolare DX Right corner version

SINGOLO LATO PER BOX DOCCIA SCORREVOLE (SOMMARE DUE LATI) SINGLE SLIDING PANEL FOR SHOWER BOX (COMBINE TWO SIDES)

Specifiche tecniche / Technical specifications			
P/D mm	H/H mm	Peso vetro kg / Glass weight kgs	Estensibilità mm / Extension mm
700	2000	23	665 - 690
750	2000	25	715 - 740
800	2000	26	765 - 790
900	2000	29	865 - 890

Specifiche tecniche / Technical specifications			
P/D mm	H/H mm	Peso vetro kg / Glass weight kgs	Estensibilità mm / Extension mm
1000	2000	32	965 - 990
1200	2000	39	1165 - 1190
1400	2000	45	1365 - 1390

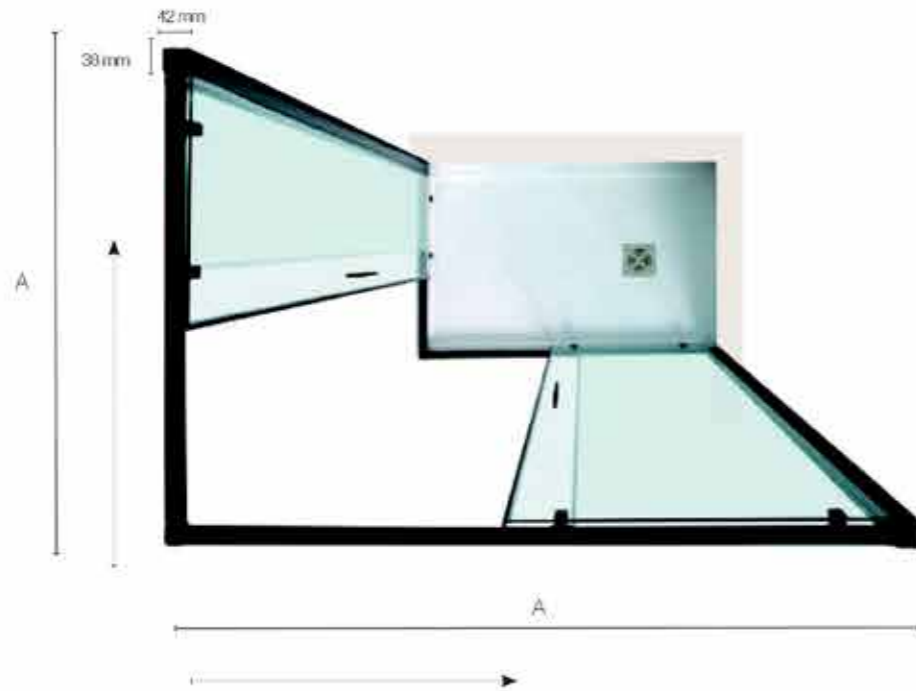

Versione angolare DX Right corner version

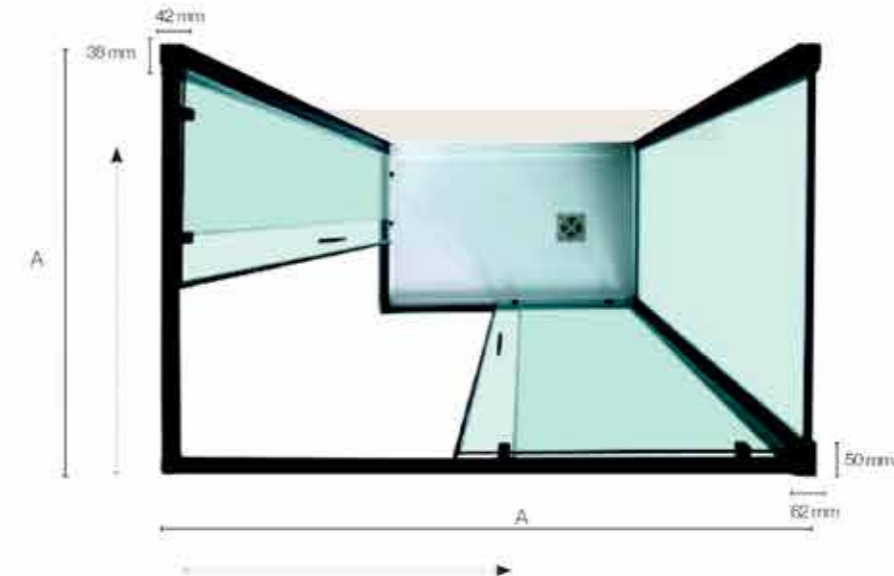

Versione centro parete Center wall version

APERTURA PORTA OPENING DOOR

RAPID MM	700	750	800	900	1000	1200	1400
700	344	362	380	423	465	554	646
750	362	380	398	437	478	565	655
800	380	398	415	453	492	577	665
900	423	437	453	485	523	603	688
1000	465	478	492	523	556	630	714
1200	554	565	577	603	630	698	773
1400	646	655	665	688	714	773	839

BOX DOCCIA SCORREVOLE CENTRO PARETE (SOMMARE DUE LATI + LATO FISSO) SHOWER BOX CENTER WALL (COMBINE TWO SIDES + FIXED PANEL)

Specifiche tecniche / Technical specifications			
P/D mm	H/H mm	Peso vetro kg / Glass weight kgs	Estensibilità mm / Extension mm
700	2000	23	677 - 702
750	2000	25	727 - 752
800	2000	26	777 - 802
900	2000	29	877 - 902
1000	2000	32	977 - 1062
1200	2000	39	1177 - 1202
1400	2000	45	1377 - 1402

DIMENSIONI LATO FISSO (B) FIXED SIDE PANEL SIZE (B)

Specifiche tecniche / Technical specifications			
P/D mm	H/H mm	Peso vetro kg / Glass weight kgs	Estensibilità mm / Extension mm
700	2000	24	665-715
800	2000	27	765-815
900	2000	30	865-915

concept e ideazione grafica
GEK comunicazione

stampa
Telligraf

© Kerasan aprile 2022

KERASAN

Kerasan srl

Via Einstein, 3

01033 Civita Castellana (VT) - ITALY

Tel. (+39) 0761 542018 (ra) - Fax (+39) 0761 540627

www.kerasan.it kerasan@kerasan.it

La Kerasan si riserva di apportare in qualsiasi momento modifiche tecniche, costruttive e dimensionali utili al miglioramento dei propri prodotti; pesi e misure sono da considerarsi indicativi.

- La tonalità degli smalti dei sanitari, a causa delle peculiarità della lavorazione ceramica, sono suscettibili di lievi variazioni da considerarsi in tolleranza.
- Gli allestimenti fotografici sono realizzati a fini estetici e non indicano soluzioni d'installazione.

Kerasan has the right to make any change to improve its products anytime; weights and sizes are for information only.

- The tonalities of glazes on sanitary ware are subject to light alterations due to the peculiarity of the production process, the alterations have to be considered as tolerance.
- The settings have been realized for aesthetic use only, they just suggest interior bath decorations.

KERASAN

Kerasan srl

Via Einstein, 3

01033 Civita Castellana (VT) - ITALY

Tel. (+39) 0761 542018 (ra)

Fax (+39) 0761 540627

www.kerasan.it kerasan@kerasan.it